

1. 3 8 « ».
2. « »
3. «D»
4. -
5. : 10 = 50 Nm; 12 = 79 Nm.
VH 8879 0168
6. -

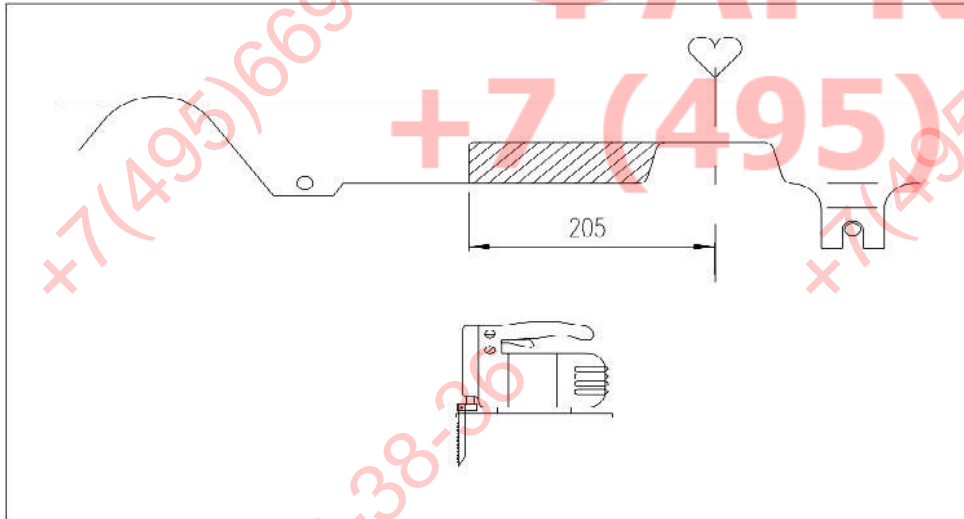

ФАРКОП.РФ

+7 (495) 669-38-36

12 1,25 75	2 .
10 35	4 .
8 50	4 .
8	4 .
10	8 .
12 1,25 (/ .)	2 .
8 (.)	4 .
10 (.)	6 .
8.37 (.)	8 .
10.37 (.)	4 .
10.37	4 .
12.37	4 .
VH 8879	1 .
0168	1 .
à16-6	1 .
	1 .
	1 .

Момент затяжки	
M6	9,5 Nm
M8	23 Nm
M10	46 Nm
M12	79 Nm
M14	125 Nm
M16	195 Nm
M10x1,25	49 Nm
M12x1,25	87 Nm
M12x1,5	83 Nm

	1 .
	1 .
	1 .
	1 .
	1 .









462800, « - »
18
: (35363) 7-05-06
/ : (35363) 7-13-20
(495) 799-13-46
www.bosal-autoflex.ru
www.bosal.com
info@bosal-autoflex.ru

bosal

..... :

..... VIN

.....

-	26 35 Citroen C4 HB	 					D	
	 2011/1 →		1730	1100	75	18,07	6,59 кН.	Bosal Autoflex Russia BAR 28

bosal

