

# 31-77 / 332264600001 / 332265600001

**ATTENTION : (pour connaître les caractéristiques d'utilisation consulter la carte grise).**

Installé suivant nos recommandations, cet attelage vous donnera entière satisfaction. Nous dégageons toute responsabilité en cas de transformation ou d'utilisation illicite de celui-ci

**FR**

**ACHTUNG: (Nutzungsmerkmale : siehe Fahrzeugschein)**

Diese Anhängervorrichtung wird Sie voll zufrieden stellen, wenn Sie unsere Montageanleitung befolgen. Im Falle der unerlaubten Veränderung oder des unerlaubten Gebrauchs lehnen wir jede Haftung ab.

**DE**

**PLEASE NOTE : (to familiarise yourself with the operating characteristics refer to the log).**

If this tow bar is fitted in accordance with our recommendations it will give a completely satisfaction. We cannot accept any responsibility in the event of changes to or improper use of this item.

**EN**

**BEMÆRK : (for yderligere oplysninger om anvendelsesforhold henvises der til registreringsattesten)**

Hvis dette anhængertræk monteres i henhold til vores anvisninger, vil det være til din fulde tilfredshed. Vi fralægger os ethvert ansvar ved ulovlig ændring eller brug af anhængertrækket.

**DA**

**ΠΡΟΣΟΧΗ : (για να πληροφορηθείτε τα χαρακτηριστικά χρήσης συμβουλευτείτε την κάρτα)**

Εγκατεστημένο σύμφωνα με τις συστάσεις μας, αυτό το σύστημα ρυμούλκησης θα σας ικανοποιήσει πλήρως. Απεκδύομεθα πάσης ευθύνης σε περίπτωση μετατροπής ή παράνομης χρήσης αυτού.

**EL**

**ATENCIÓN: (para conocer las características de utilización, consultar el permiso de circulación)**

Instalado siguiendo nuestras recomendaciones, este enganche le dará total satisfacción. No asumiremos ninguna responsabilidad en caso de que haya sido transformado o utilizado ilícitamente.

**ES**

**UWAGA (charakterystyki użytkowania należy sprawdzić w dowodzie rejestracyjnym)**

Dyszel holowniczy będzie funkcjonował we właściwy sposób po zainstalowaniu go zgodnie z zaleceniami. Nie ponosimy żadnej odpowiedzialności w przypadku wprowadzenia zmian lub niedozwolonego użycia

**PL**

**HUOMIO: (käyttöominaisuuksiin tutustumiseksi on katsottava rekisteriotetta)**

Suosituksen mukaan asennettuna tämä vetokoukku täyttää odotuksesi. Emme ota vastuuta, jos laitetta muutetaan tai käytetään ohjeiden vastaisesti.

**FI**

**ATTENZIONE : (per conoscere le caratteristiche d'uso consultare il libretto di circolazione)**

Installato seguendo le nostre raccomandazioni, questo gancio da traino vi lascerà completamente soddisfatti. Respingiamo ogni responsabilità in caso di trasformazione o utilizzo illecito dello stesso.

**IT**

**LET OP : (voor gebruikskennmerken het kentekenbewijs raadplegen)**

Indien u de koppeling volgens onze aanbevelingen heeft geïnstalleerd, zal het u tot volle tevredenheid stemmen. Wij stellen ons niet aansprakelijk in geval van wijziging of onrechtmatig gebruik.

**NL**

**ADVARSEL: (for kunnskap om bruksegenskapene, se vognkortet)**

Ved å installere innretningen i samsvar med våre anbefalinger vil du få maksimalt utbytte av dette tilhengerfestet. Vi fraskriver oss alt ansvar hvis tilhengerfestet endres eller brukes på ulovlig måte.

**NO**

**POZOR: (užívateľské charakteristiky naleznete v technickém průkazu)**

Tažné zařízení instalované dle našich doporučení vás plně uspokojí. V případě přestavby nebo neoprávněného užívání se zbavujeme veškeré odpovědnosti

**CZ**

**VARNING: (Läs igenom registreringsbeviset för att ta reda på rådande användningsvillkor)**

Om du monterar produkten enligt våra anvisningar kommer du uppnå bästa möjliga resultat. Vi avsäger oss allt ansvar i de fall kunden inte följt våra anvisningar fullt ut.

**SV**

**FIGYELEM : (a használati jellegzetességeket a forgalmi engedélyből ismerheti meg)**

A vonóhorog előírásainak megfelelő felszerelés esetén a terméket teljes elégedettséggel használhatja. A termék átalakítása vagy tiltott használata esetén semmilyen felelősséget nem vállalunk.

**HU**

**ВНИМАНИЕ : (чтобы ознакомиться с рабочими характеристиками, изучите технический паспорт автомашины)**

Установленное при соблюдении рекомендаций, данное тягово-сцепное устройство в полной мере удовлетворит ваши потребности. Производитель не несет никакой ответственности в случае деформации или

**RU**



**SIARR**

**WESTFALIA**

**31 - 77  
SI131**

**332264600001  
SI134**

**332265600001  
SI132**

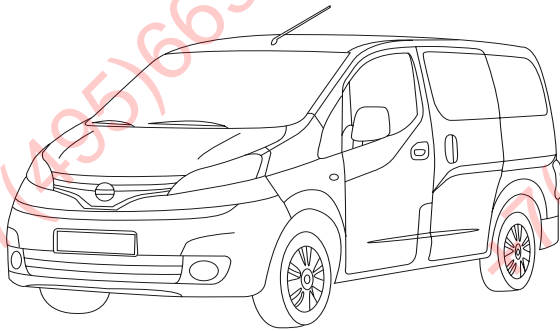

**NISSAN NV200**



2 000 kg

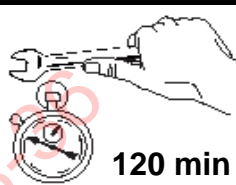

120 min



75 kg



1 100 kg

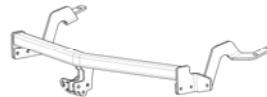

3177 : 21,68 kg  
332264 : 18 kg  
332265 : 19,9 kg



7,5 kN



e6\*94/20\*00\*0867 - 3177  
e6\*94/20\*00\*0878 - 332264  
e6\*94/20\*00\*0876 - 332265

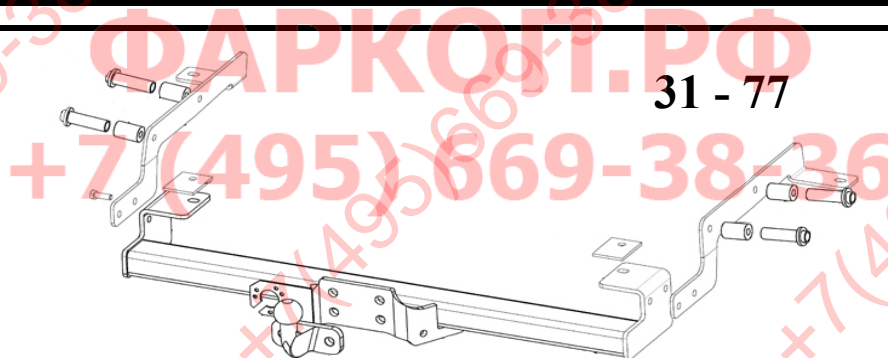
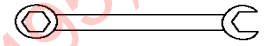
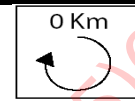

**31 - 77**

**332264**

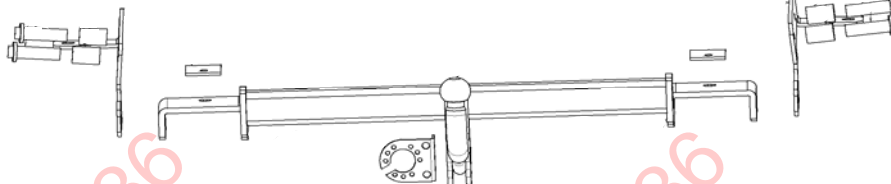



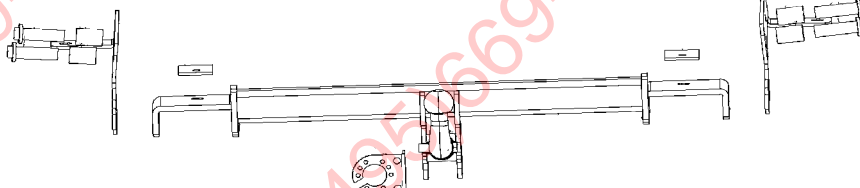



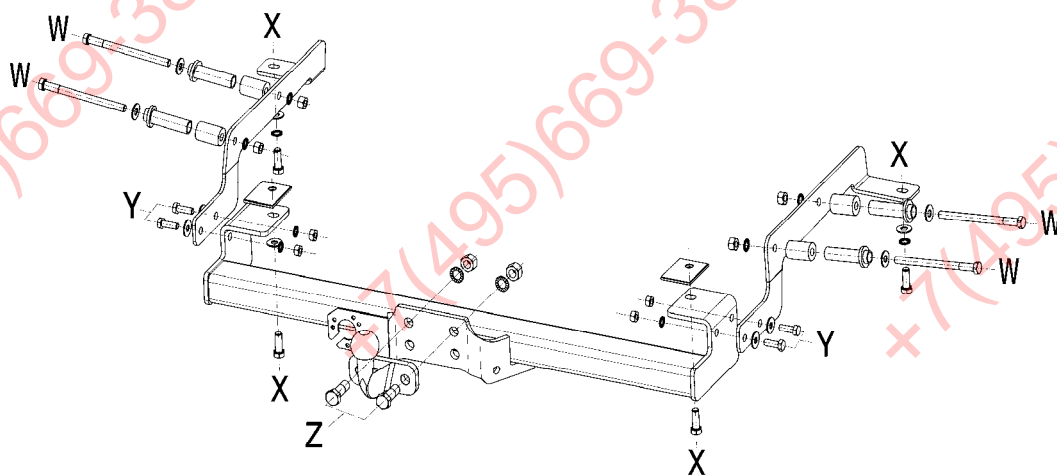









**332265**











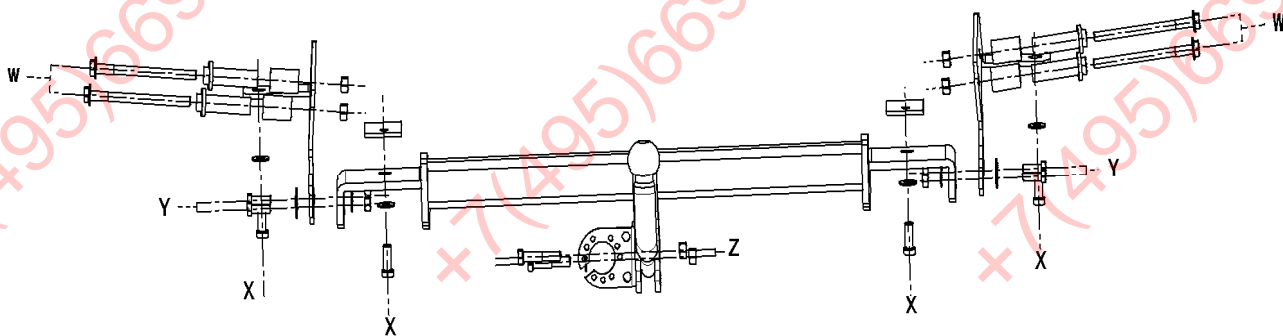







31 - 77



VISSERIE		QTÉ
<b>W</b>	 HM12x60 - cl 8.8 - 65 Nm	x 4
	 DEC12	x 4
	 L 12,5/27	x 4
	 M12 - cl8 - 65 Nm	x 4
	 12,5/30 lg.45mm	x 4
	 Ø 17/12,5 lg85mm	x 4
<b>X</b>	 HM12x30 - cl 8.8 - 65 Nm	x 4
	 L 12,5/27	x 4
	 DEC12	x 4
<b>Y</b>	 HM10x30 - cl 8.8 - 40 Nm	x 4
	 L 10,5/27	x 4
	 DEC10	x 4
	 M10 - cl 8 - 40 Nm	x 4
<b>Z</b>	 HM16x45 - cl 8.8 - 170 Nm	x 2
	 DEC16	x 2
	 M16 - cl 8.8 - 170 Nm	x 2









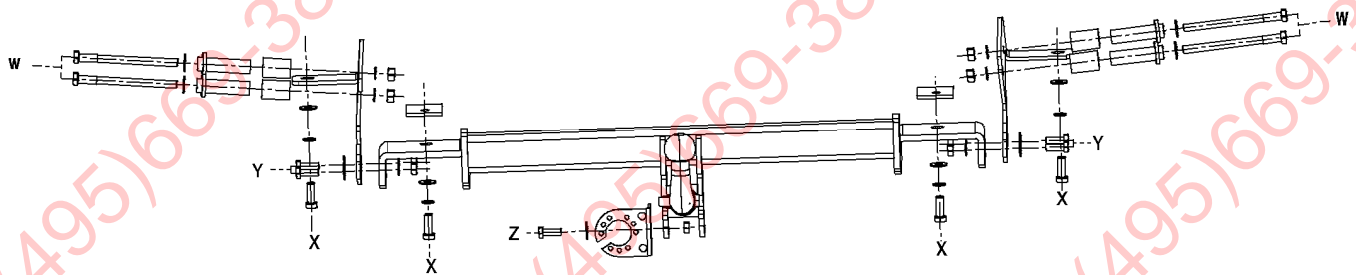







# 332 264 600 001



VISSERIE		QTÉ
<b>W</b>	 HM12x60 - cl 8.8 - 65 Nm	x 4
	 DEC12	x 4
	 L 12,5/27	x 4
	 M12 - cl8 - 65 Nm	x 4
	 12,5/30 lg.45mm	x 4
	 Ø 17/12,5 lg85mm	x 4
<b>X</b>	 HM12x30 - cl 8.8 - 65 Nm	x 4
	 L 12,5/27	x 4
	 DEC12	x 4
<b>Y</b>	 HM10x30 - cl 8.8 - 40 Nm	x 4
	 L 10,5/27	x 4
	 DEC10	x 4
	 M10 - cl 8 - 40 Nm	x 4
<b>Z</b>	 HM12x60 - cl 8.8 - 65 Nm	x 2
	 L 12/27	x 2
	 M12 - cl 8 - 65 Nm	x 2

# 332 265 600 001



VISSERIE		QTÉ
<b>W</b>	 HM12x60 - cl 8.8 - 65 Nm	x 4
	 DEC12	x 4
	 L 12,5/27	x 4
	 M12 - cl8 - 65 Nm	x 4
	 12,5/30 lg.45mm	x 4
	 Ø 17/12,5 lg85mm	x 4
<b>X</b>	 HM12x30 - cl 8.8 - 65 Nm	x 4
	 L 12,5/27	x 4
	 DEC12	x 4
<b>Y</b>	 HM10x30 - cl 8.8 - 40 Nm	x 4
	 L 10,5/27	x 4
	 DEC10	x 4
	 M10 - cl 8 - 40 Nm	x 4
<b>Z</b>	 HM12x60 - cl 8.8 - 65 Nm	x 2
	 L 12/27	x 2
	 M12 - cl 8 - 65 Nm	x 2

3322646000013  
32265600001



~~31-77~~

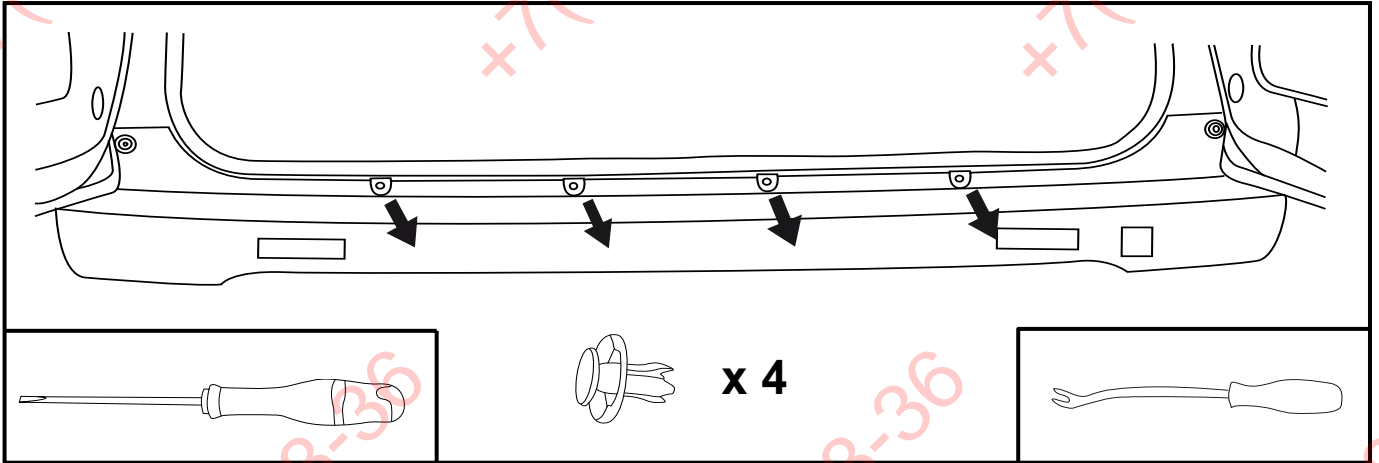
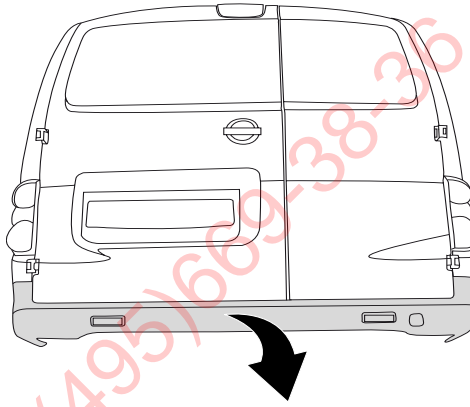

**ФАРКОИ.РФ**

**+7 (495) 669-38-36**

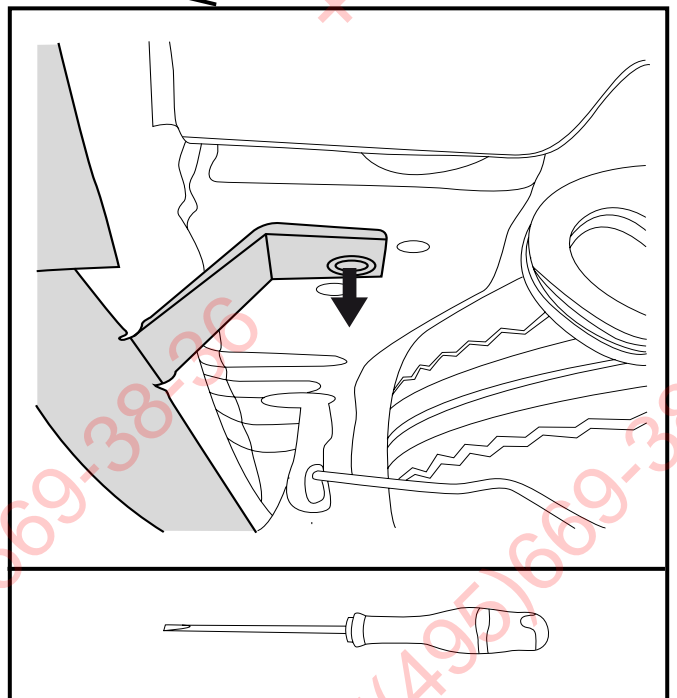
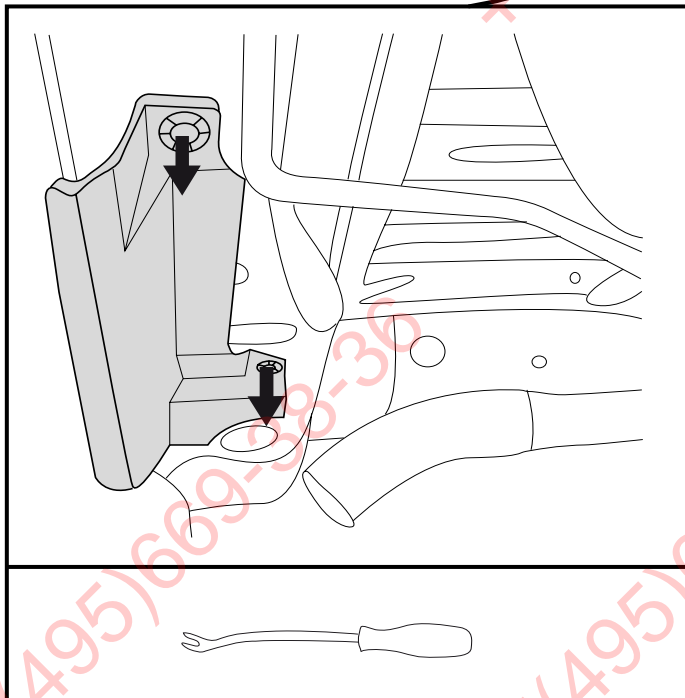

3322646000013  
32265600001

~~31-77~~

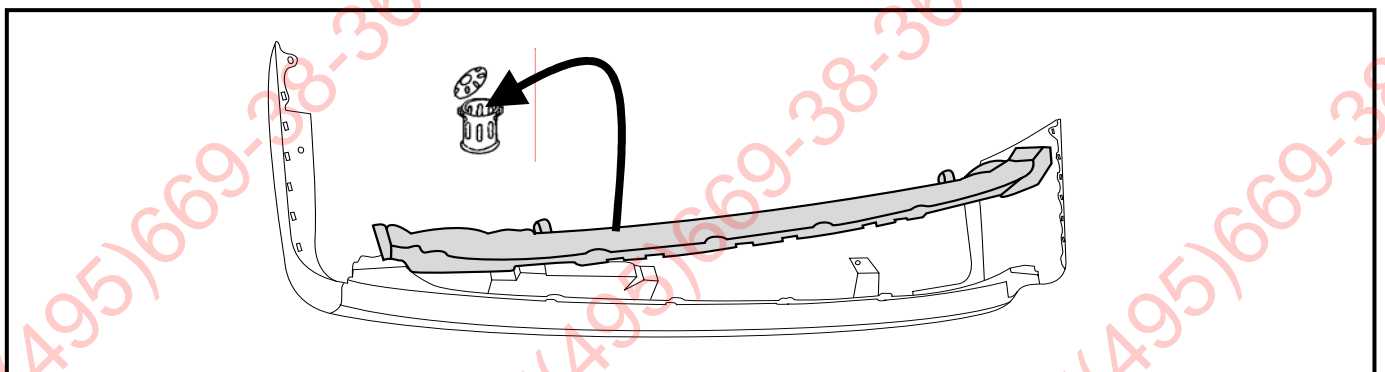
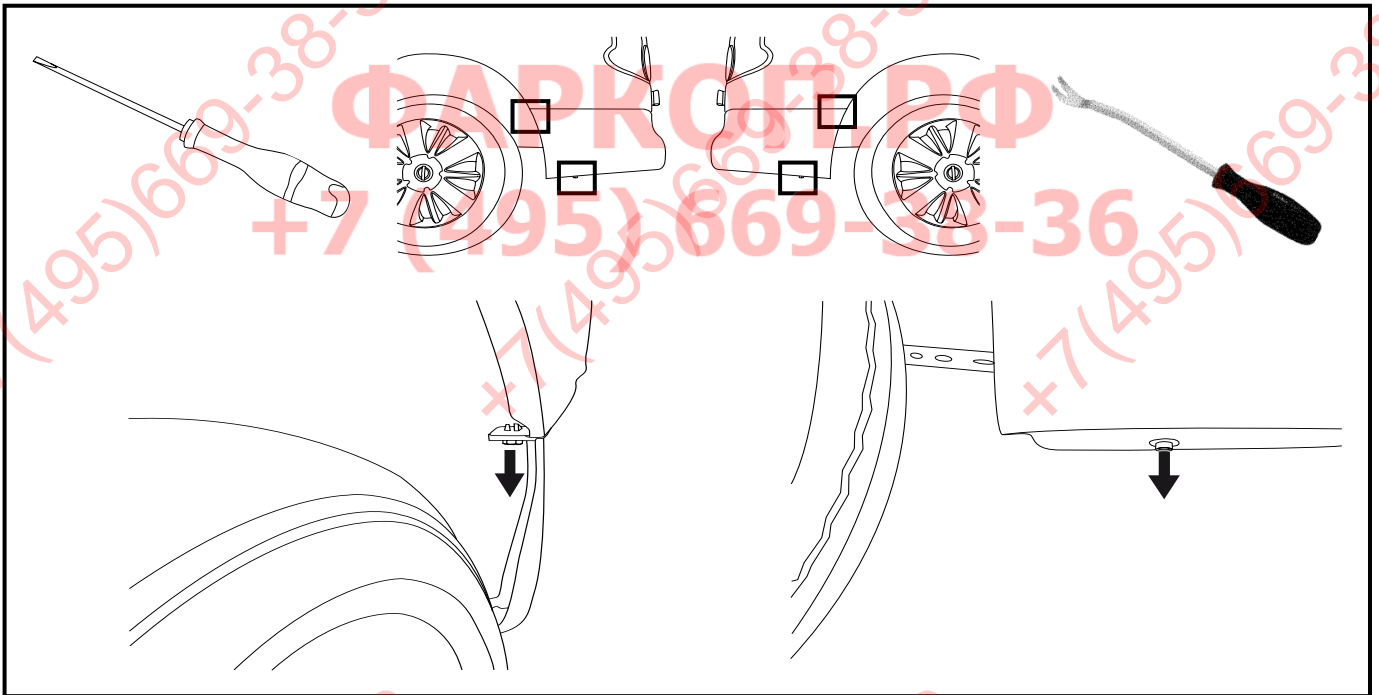
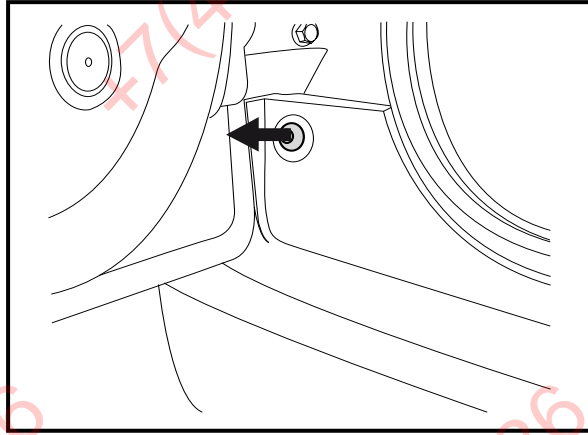
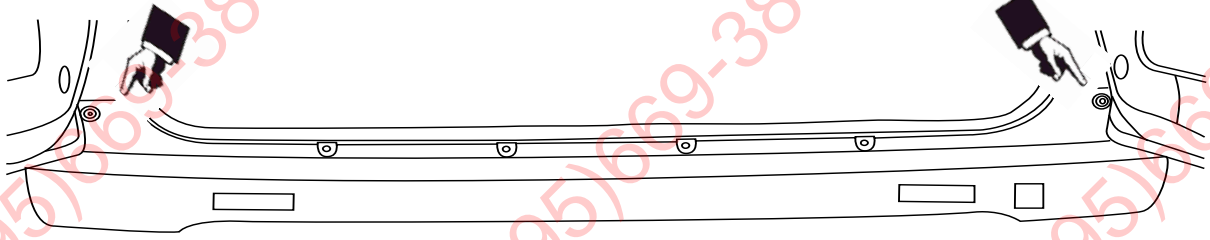

31 - 77

3322646000013

32265600001

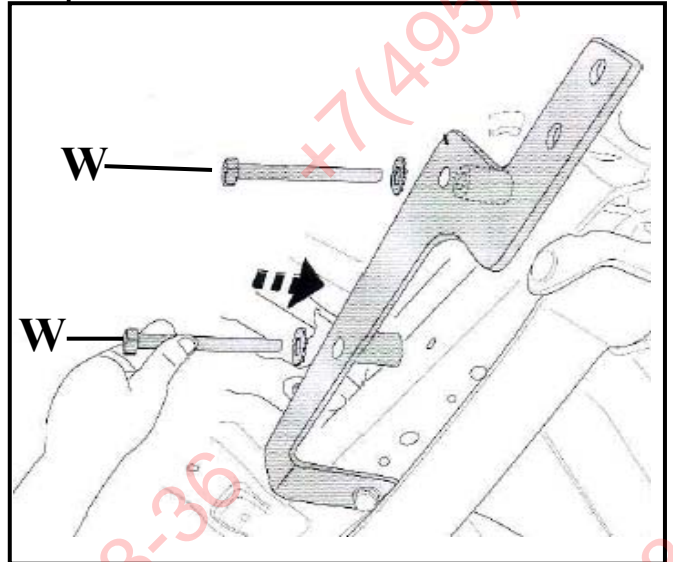
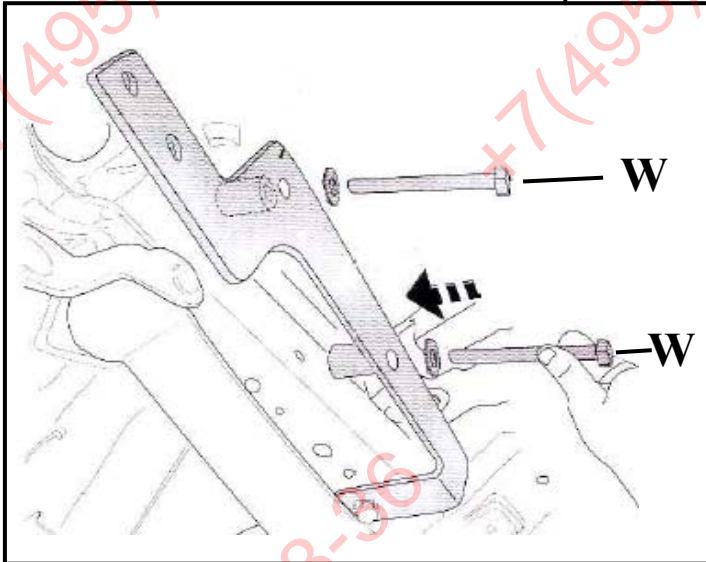
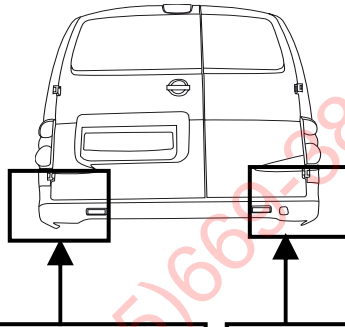

**ФАРКОЛ.РФ**  
**+7 (495) 669-38-36**

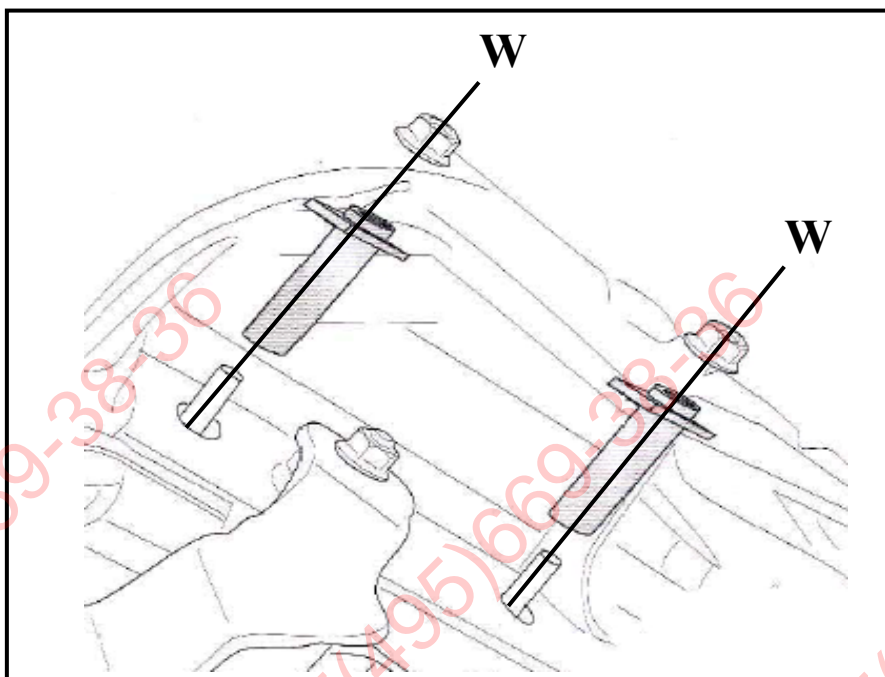
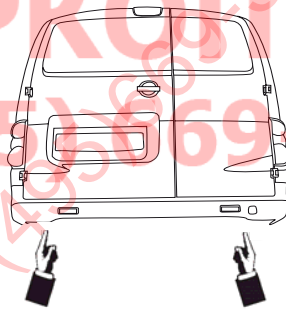



31 - 77

3322646000013

32265600001

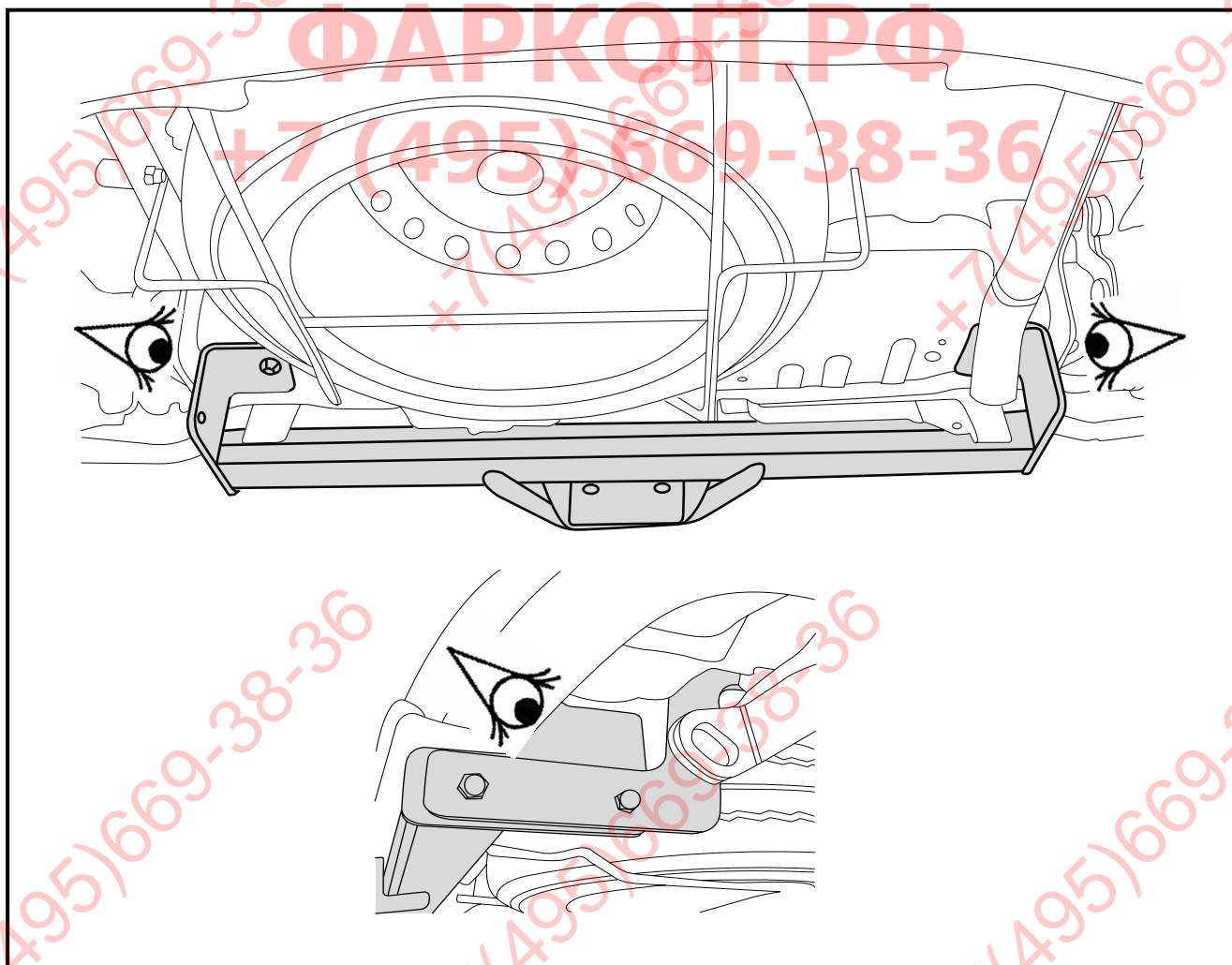
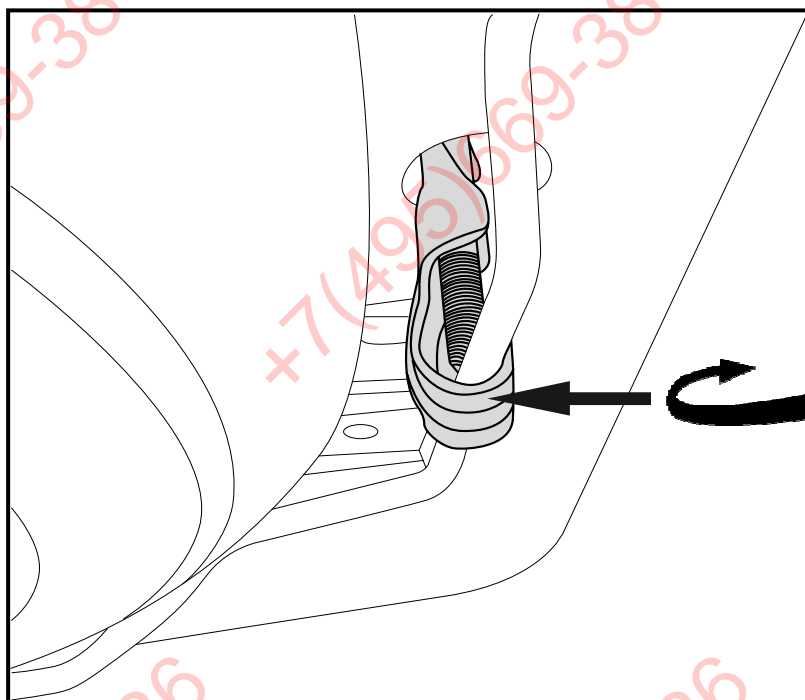

3322646000013  
32265600001

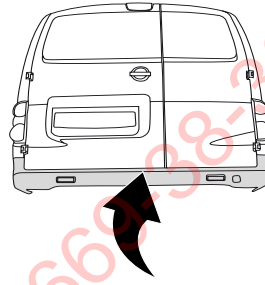

~~31-77~~

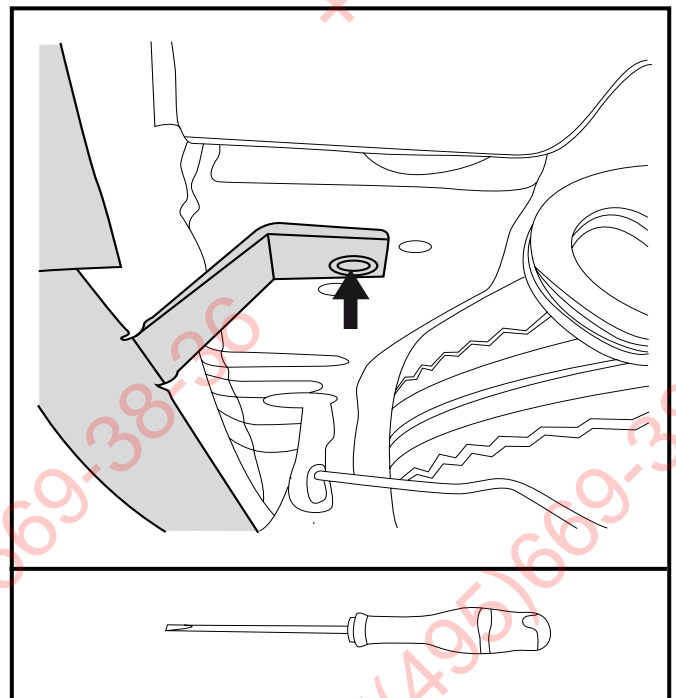
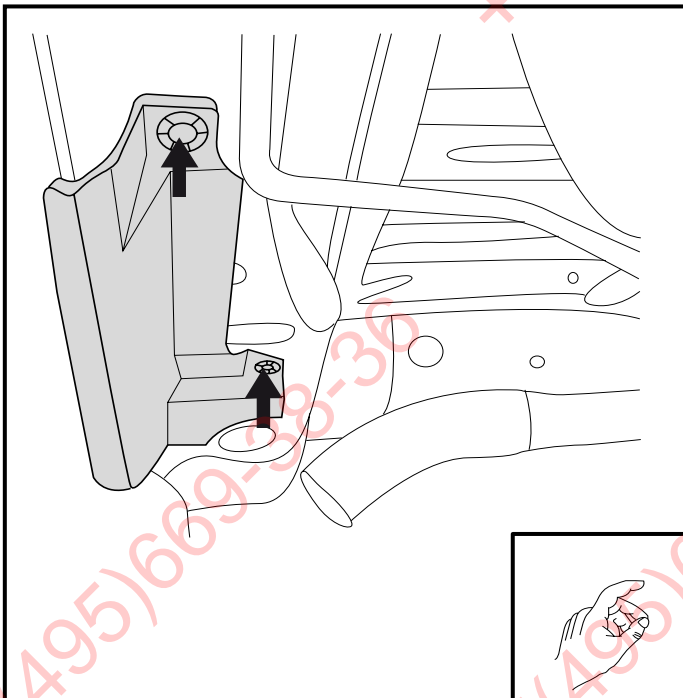
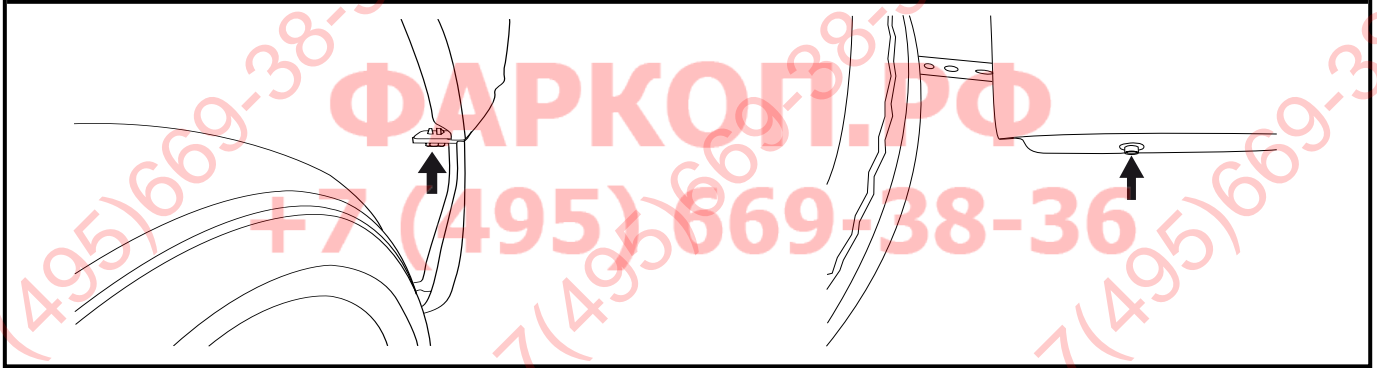
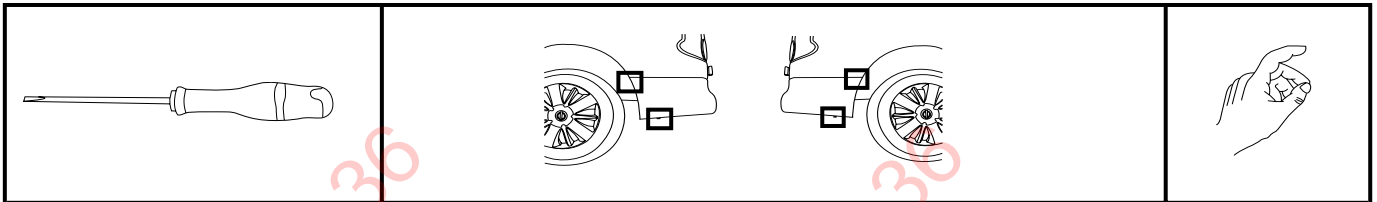
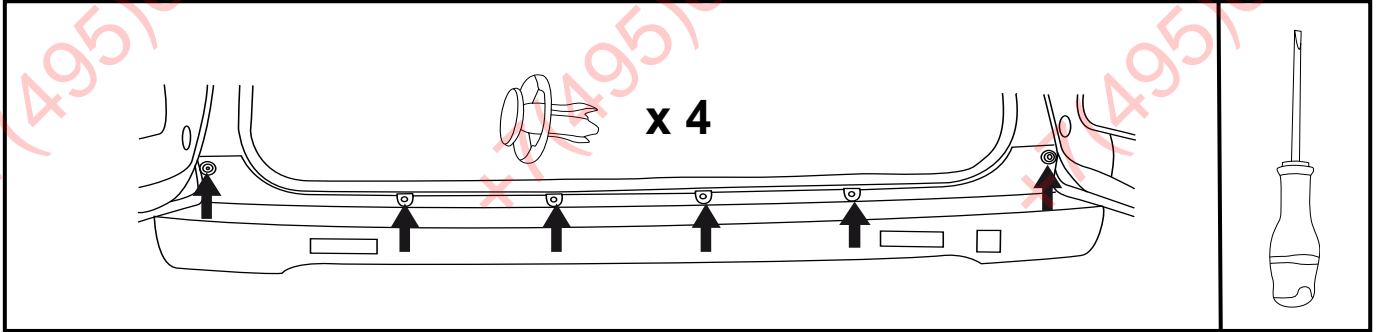

332 264 600 001



~~332265600001~~

~~31 - 77~~

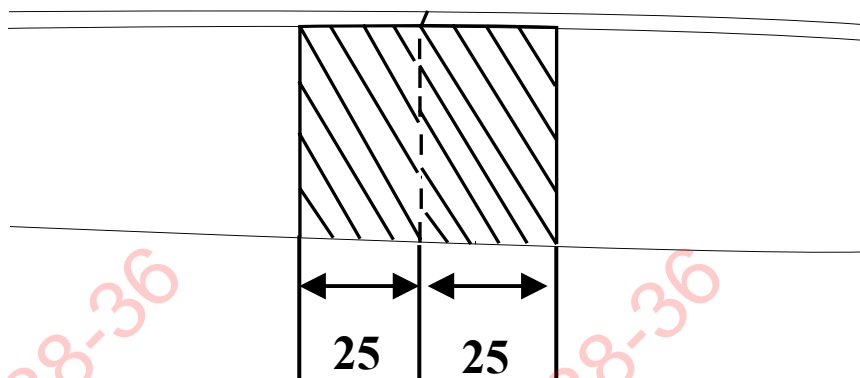
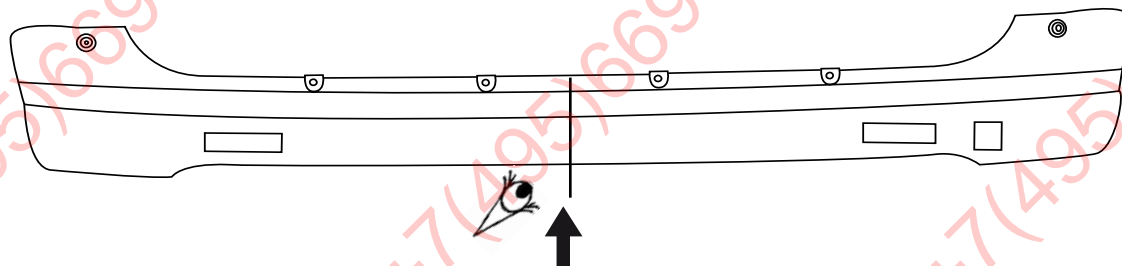

332 265 600 001



~~332264600001~~

~~31 - 77~~

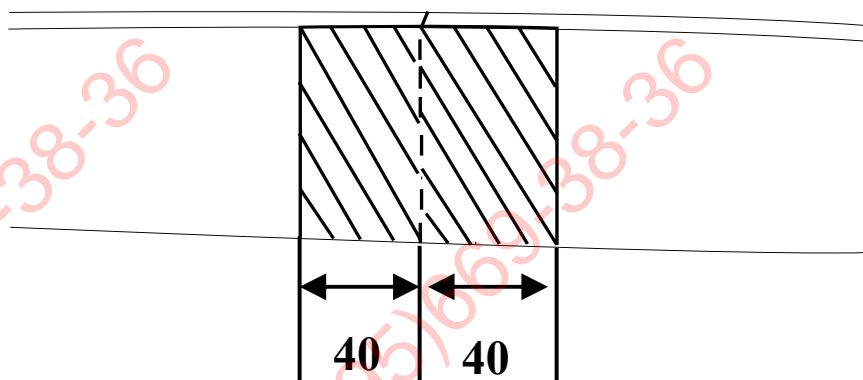
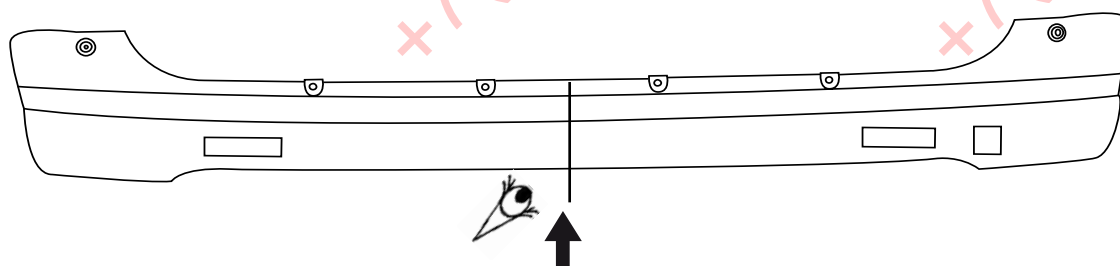

**31 - 77**

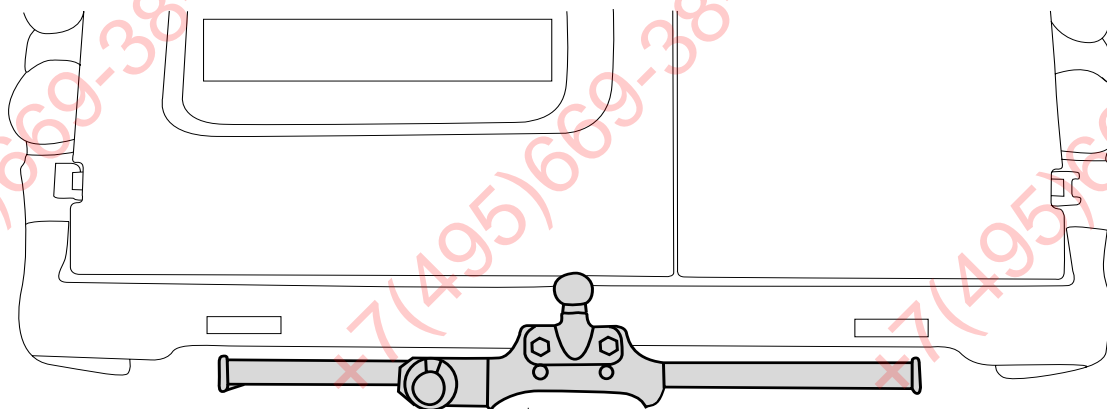

**332 264 600 001**

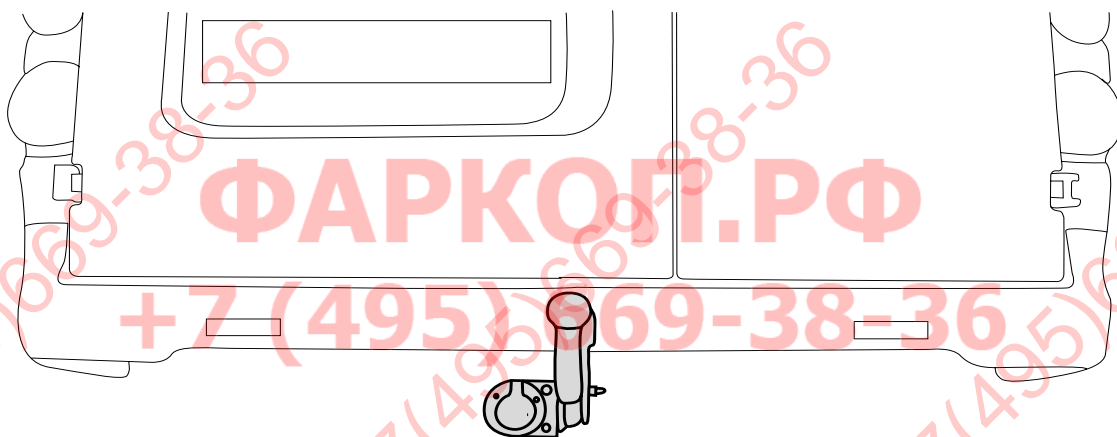

**332 265 600 001**

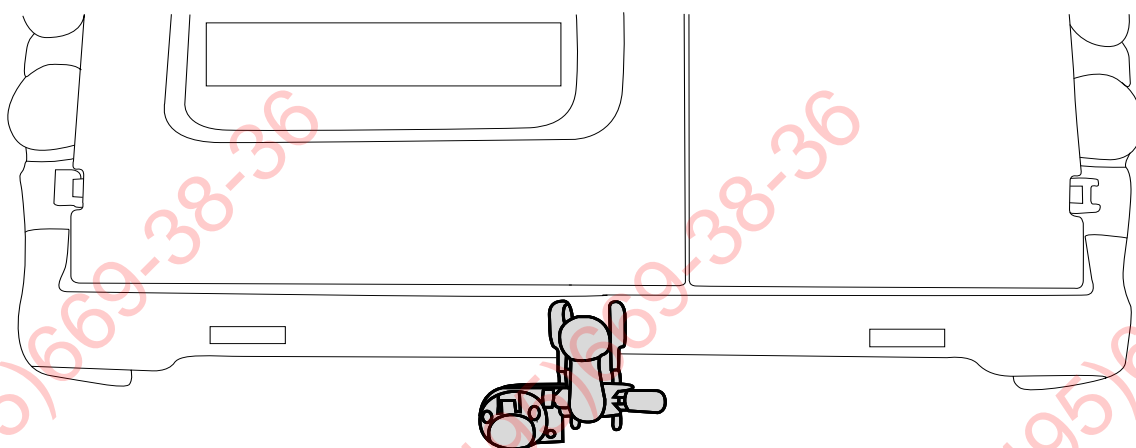

Dispositivo di traino tipo : **31 - 77 - 33226460001 - 332265600001**  
Per autoveicolo : **Nissan NV200**  
Tipo funzionale : **X11**



Classe e tipo di attacco : **A50-X**  
Omologazione : **e6\*94/20\*00\*0867 (31-77) / e6\*94/20\*00\*0878 (332264) / e6\*94/20\*00\*0876 (332265)**  
Valore D : **7,5 kN**  
Carico verticale max. S : **75 kg**  
Massa rimorchiabile : **vedi carta di circolazione dell'autoveicolo**

In base alla Direttiva europea 94/20, la massa massima rimorchiabile del dispositivo di traino è determinata dal valore di prova "D" così definito :

$$D = (T \times C) / (T + C) \times 0,00981 = 7,5 \text{ kN}$$

dove : T = Massa complessiva max. della motrice (in kg) e C = Massa rimorchiabile max. della motrice (in kg)

#### DICHIARAZIONE DI CORRETTO MONTAGGIO :

la sottoscritta Ditta dichiara che il dispositivo di traino tipo \_\_\_\_\_ è stato installato a regola d'arte, nel rispetto dei punti d'attacco e delle prescrizioni fornite dalla Casa costruttrice

sul veicolo Berlingo/Partner

targato \_\_\_\_\_

li \_\_\_\_\_

Si dichiara inoltre di aver informato l'utente del veicolo sull'USO e MANUTENZIONE del dispositivo stesso.

timbro et firma