



RENAULT TRAFIC
OPEL VIVARO
NISSAN PRIMASTAR

2001 -
2001 -
09/2002 -

Cat. No. R/024

e20

e20*94/20*0014*00

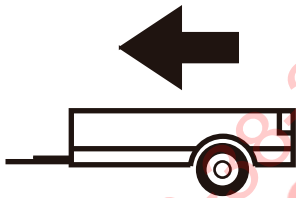

2000Kg

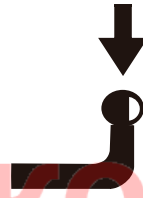

80Kg

D = 11,70kN

D (kN) =



MAX kg

x

MAX kg

x 0,00981



MAX kg

+

MAX kg

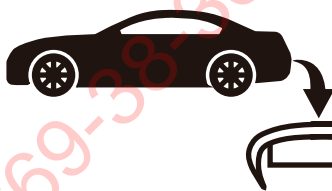

IMIOLA HAK-POL

96-111 KOWIESY, CHOJNATA 23A, POLAND

tel. +48 46 831 73 31, fax +48 831 74 29

e-mail: office@imiola.pl, www.imiola.pl

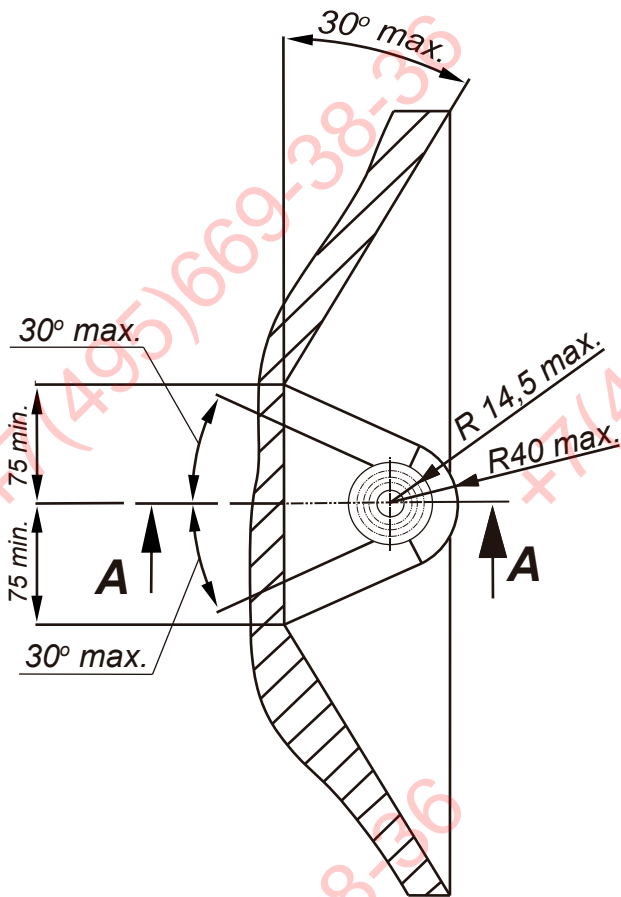

PRZEKRÓJ A-A

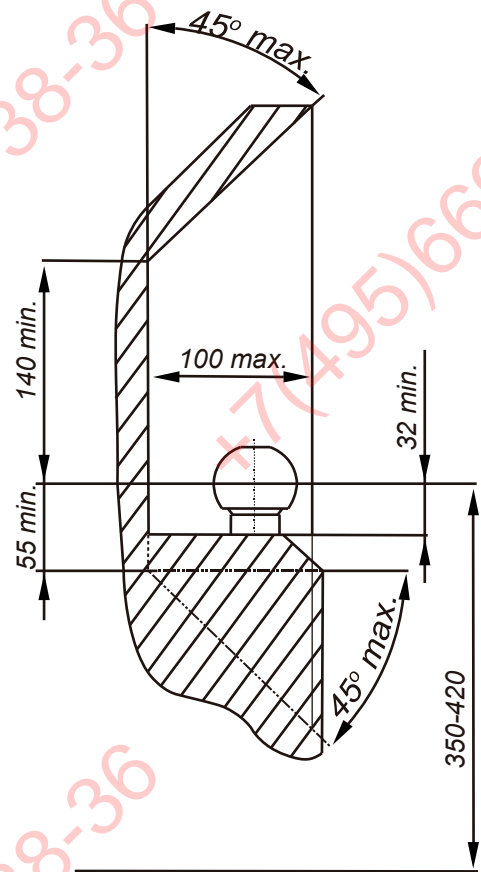

ФАРКОЛ.РФ

PL Należy zagwarantować przestrzeń swobodną według załącznika VII, rysunek 25a/b Regulaminu EKG ONZ 55.01 przy dopuszczalnym ciężarze całkowitym pojazdu.

F L'espace libre doit être garanti conformément à l'annexe VII, illustration de la réglementation 55.01 CE pour un poids total en charge autorisé du véhicule.

GB The clearance specified in appendix VII, diagram 25a/b of Regulation No. 55.01 UN EU must be guaranteed at laden weight of the vehicle.

D Der Freiraum nach Anhang VII, Abbildung 25a/b der Vorschriften 55.01 EG ist zu gewährleisten bei zulässigem Gesamtgewicht des Fahrzeuges.

Moment skracający dla śrub i nakrętek (8.8) Torque settings for nuts and bolts (8.8)	
M8	25Nm
M10	55Nm
M12	85Nm
M14	135Nm
M16	195Nm

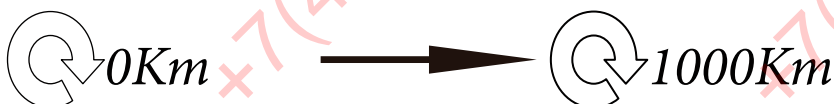

Nakrętka M12; Nut
 Podkł. spręż. 12,2; Spring Washer
 Podkł. okr. 13; Plain Washer

Nakrętka M16; Nut
 Podkł. spręż. 16,3; Spring Washer
 Podkł. okr. 17; Plain Washer

Pkt. 3

Pkt. 1

Pkt. 2

Śruba M12x35-8.8; Bolt

Pkt. 4

D

Pkt. 1

Pkt. 2

C

Śruba M16x45-8.8; Bolt
 Podkł. spręż. 16,3; Spring Washer
 Podkł. okr. 17; Plain Washer

Śruba M10x35-8.8; Bolt
 Podkł. spręż. 10,2; Spring Washer
 Podkł. okr. pow. 10,5; Plain Washer

Pkt. 3









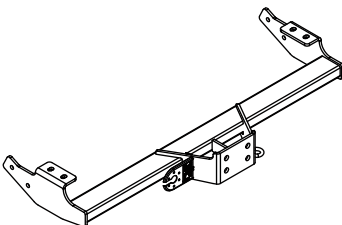
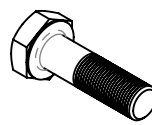
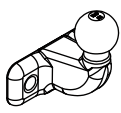

Pkt. 4

Pkt. 5

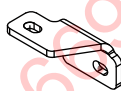
B

F

+7 (495) 669-38-36

	A	x1		M16x45	2
	B	x1		M12	6
	C	x2		17	2
	D	x1		13	6
	E	x1		16,3	2
	F	x1		10,2	6
				Ø30x10,5x3	6

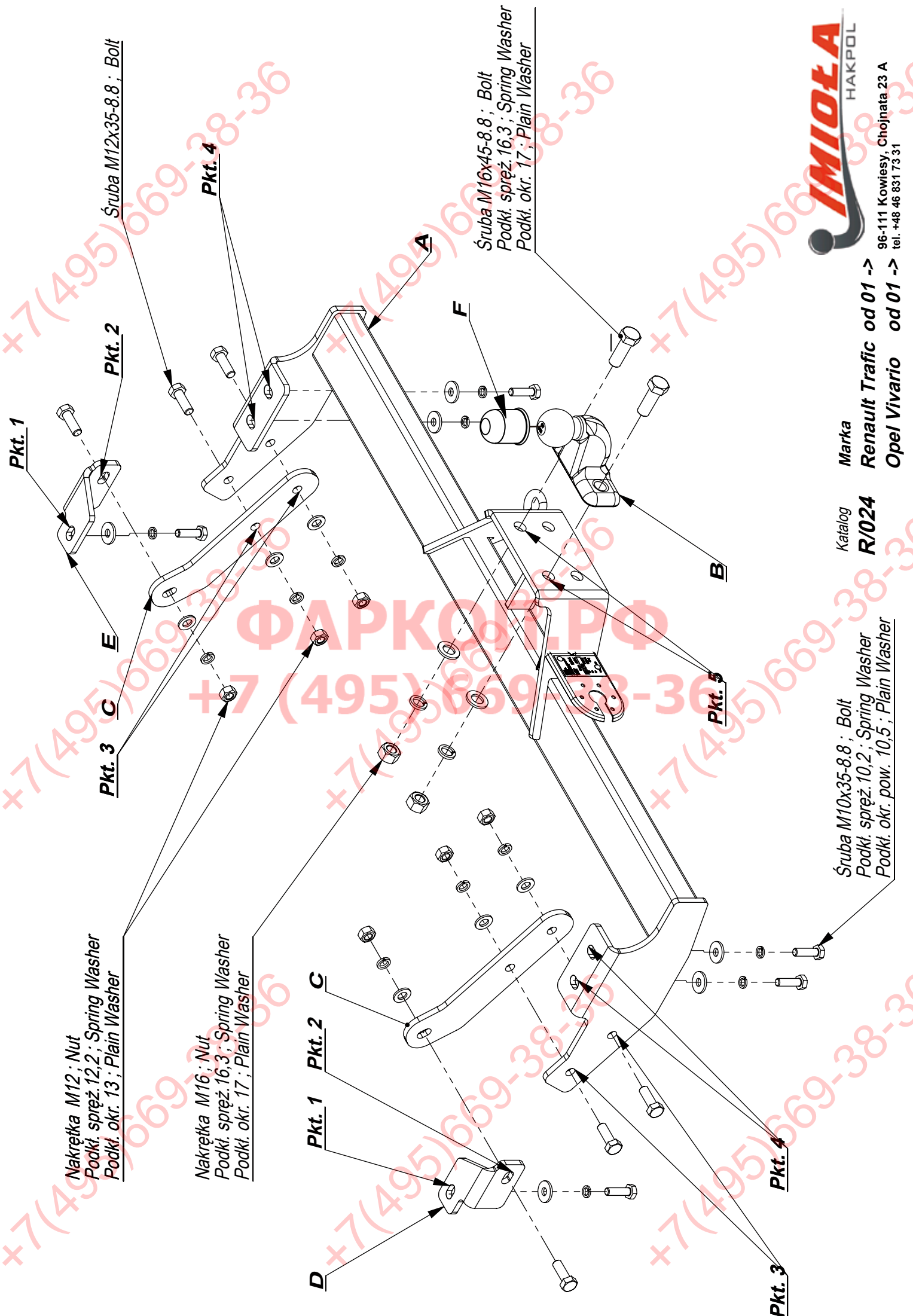

Nakrętka M12; Nut
 Podkł. spręż. 12,2; Spring Washer
 Podkł. okr. 13; Plain Washer

Nakrętka M16; Nut
 Podkł. spręż. 16,3; Spring Washer
 Podkł. okr. 17; Plain Washer

Śruba M12x35-8.8; Bolt

Śruba M16x45-8.8; Bolt
 Podkł. spręż. 16,3; Spring Washer
 Podkł. okr. 17; Plain Washer

Śruba M10x35-8.8; Bolt
 Podkł. spręż. 10,2; Spring Washer
 Podkł. okr. pow. 10,5; Plain Washer



Marka
 Renault Traffic od 01 ->
 Opel Vivario od 01 ->

Katalog
 R/024

96-111 Kowiesy, Chojnata 23 A
 tel. +48 46 831 73 31

- Belkę zaczepu A oraz elementy zaczepu D i E przykręcić luźno śrubami M10x35 8.8 do fabrycznych punktów montażu zaczepu znajdujących się w podłużnicach samochodu (pkt 1 i 4).
- Elementami zaczepu C połączyć luźno belkę zaczepu A z elementami zaczepu D i E śrubami M12x35 8.8 (pkt 2 i 3).
- Przykręcić kulę zaczepu do belki zaczepu A śrubami M16x45 8.8.
- Dokręcić wszystkie śruby z momentem wg tabeli.
- Podłączyć instalację elektryczną.

- Screw slightly the main bar A and elements D, E to the technological tow bar fitting points in the metal clamps with bolts M10x35 8.8 (point 1 and 4).
- Connect loosely the main bar A with the elements D and E using the elements C with bolts M12x35 8.8 (point 2 and 3).
- Fix the ball to the main bar A with bolts M16x45 8.8.
- Tighten all the bolts according to the torque setting- see the table.
- Connect the electric wires.

- Serrer légèrement la traverse d'attache A et les éléments de fixation D et E par les boulons M10x35 8.8 aux points de fixation de longerons de voiture (point 1 et 4) prévus par le fabricant.
- Pointer les éléments de fixation C de la traverse d'attache A aux éléments D et E par les boulons M12x35 8.8 (point 2 et 3).
- Visser le crochet d'attelage à la traverse d'attache par les boulons M16x45 8.8.
- Serrer tous les boulons avec un couple de serrage selon tableau.
- Raccorder le circuit électrique.

