

 **VOLKSWAGEN POLO**
hatchback, sedan

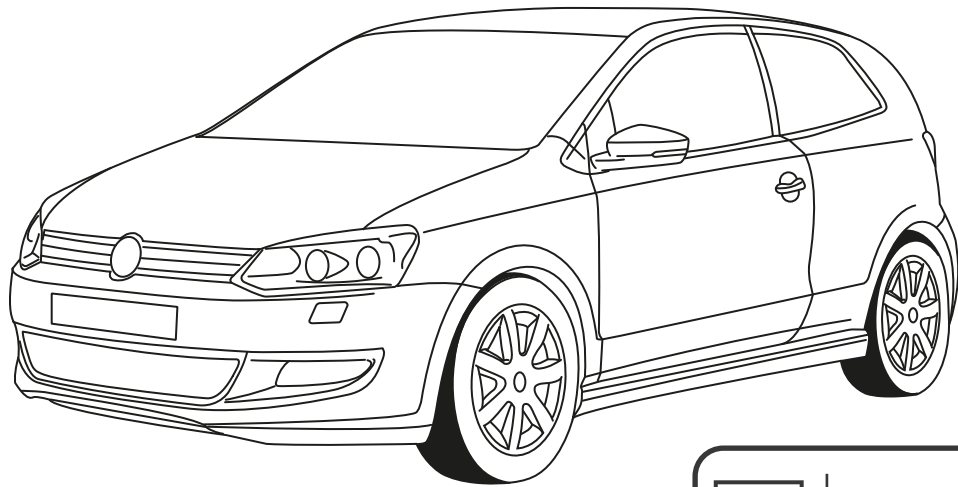





 **2009 - 2017**

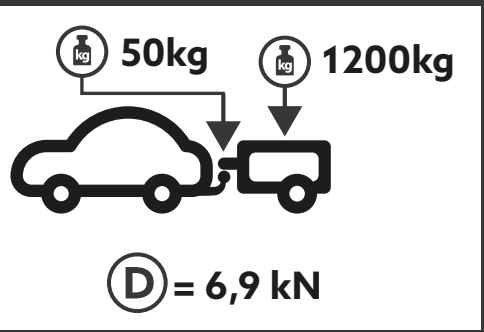

e27 | **00 0353**

$$D = \frac{\text{MAX kg} \times \text{MAX kg}}{\text{MAX kg} + \text{MAX kg}} \times 0,00981$$

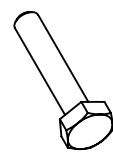
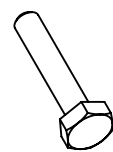
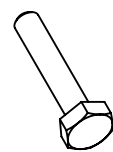
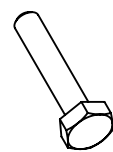
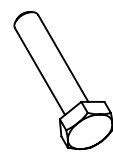

-  PR14 - 1x
-  P10 - 4x
-  P8 - 1x
-  PP10 - 4x
PP12 - 2x (A,I)
PP12 - 4x (C)
-  SM8 - 1x
-  M12 - 2x (A,I)
-  M8x40 - 1x
-  M10x35 - 4x
-  M12x70 - 2x (A)
-  M12x90 - 2x (I)
-  M12x19 - 4x (C)

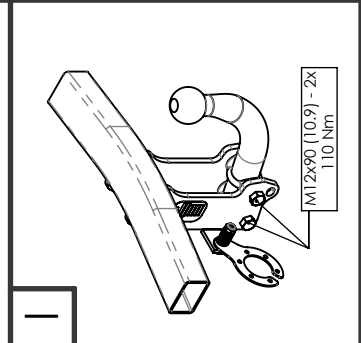
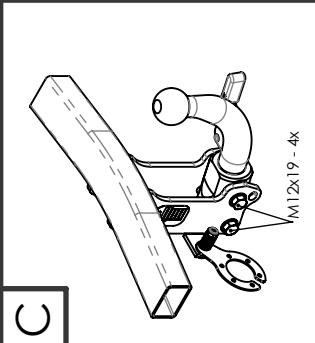
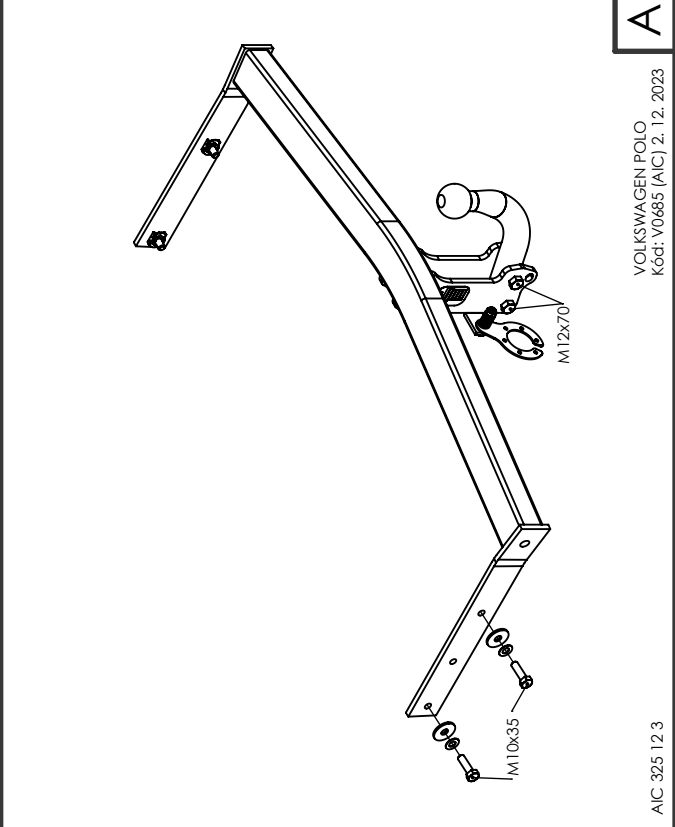

A

VOLKSWAGEN POLO
Kód: V0685 (AIC) 2. 12. 2023

AIC 325 12.3

