

➤ Instructions

Thule FreeRide 532

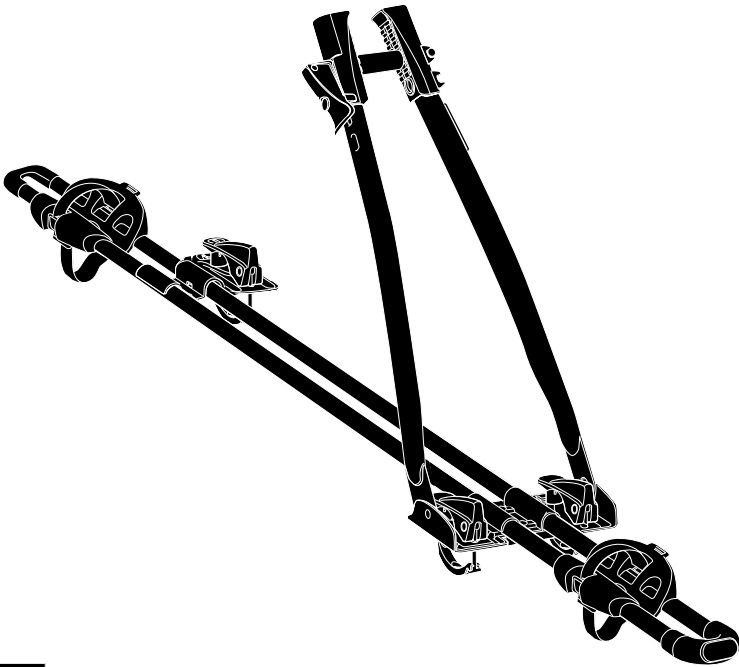

EN Roof-mounted bike carrier
FR Porte-vélo sur le toit
ES Portabicicletas de techo
DE Dachfahrradträger
NL Fietsdrager voor op het dak
PT Suporte para bicicleta para teto
IT Portabici da installare sul tetto
SV Takmonterad cykelhållare
DK Tagmonteret cykelholder
NO Takmonterte lasteholdere
FI Katolle asennettava polkupyöräteline
IS Hjólágrind á þak
ET Katusele paigaldatav jalgrattahoidik
LV Uz jumta uzstādāms velosipēdu turētājs
LT Ant stogo tvirtinami dviračių laikikliai
RU Устанавливаемое на крыше крепление для велосипедов
UK Багажник для велосипедів, що монтується на даху
PL Bagażnik rowerowy montowany na dachu
CS Nosič jízdních kol s montáží na střechu
HU Tetőre szerelhető kerékpártartó
RO Suport pentru bicicletă montat pe pavilion
SK Nosič bicyklov s montážou na strechu

SL Nosilec za kolesa
BG Покривен багажник за велосипеди
HR Krovni nosač bicikla
EL Σχάρα τοοδηλάτου οροφής
TR Araç üstüne bağlanan bisiklet taşıyıcı
MT Pembawa basikal yang dipasang pada bar bumbung

HE מנשא אופניים המורכב על גגון רכב

AR حامل الدراجة للتثبيت على السقف

ZH (CN) 顶置自行车架
ZH (TW) 車頂自行車架
JA ルーフマウント型サイクルキャリア
KO 지붕 장착 자전거 캐리어
TH โครงยึดจับจักรยานแบบติดตั้งบนหลังคา
MS Gariier tar-roti mmuntat fuq is-saqaf

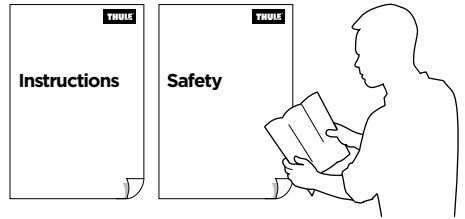

Thule FreeRide 532002, 532004, 532005, 532010

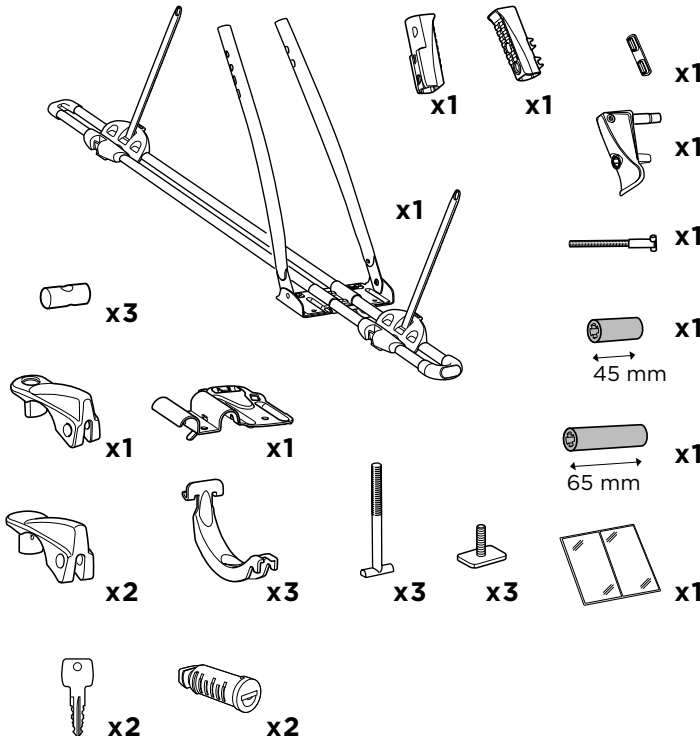

i

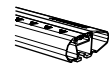

Thule WingBar Evo

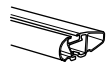

Thule WingBar

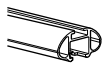

Thule AeroBar

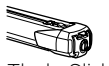

Thule SlideBar

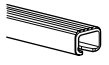

Thule SquareBar

i

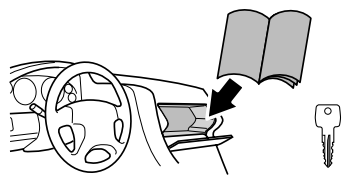
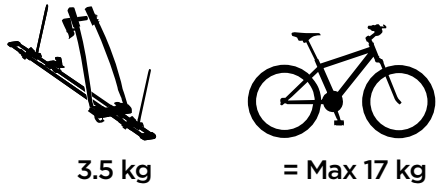
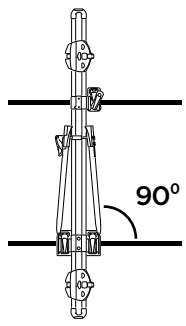
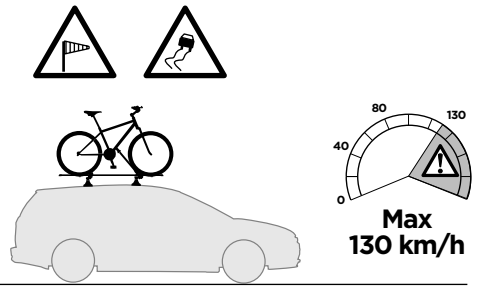
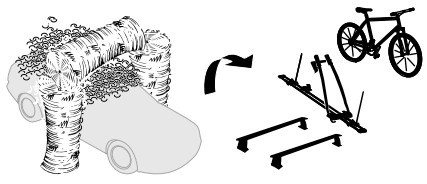
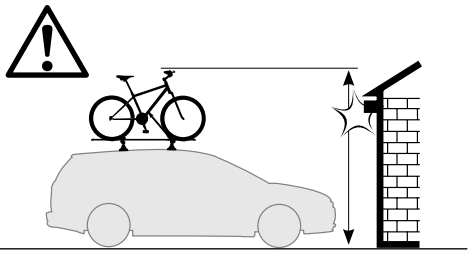
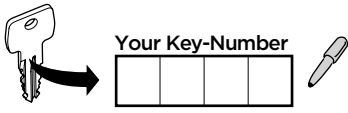

1

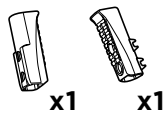
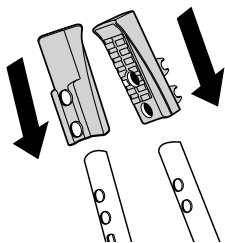

2

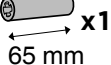
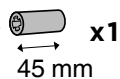

$\varnothing 22 - 58 \text{ mm}$

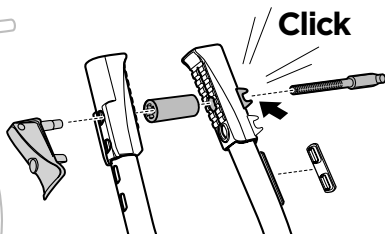
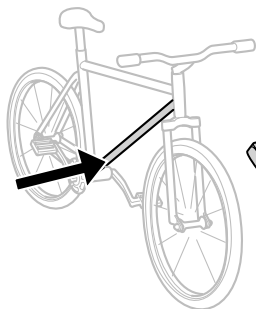

$\varnothing 59 - 70 \text{ mm}$
Max
65 x 80 mm

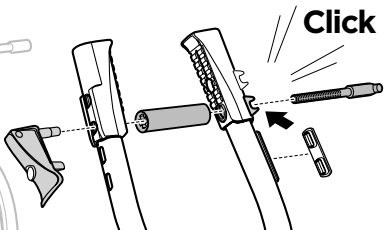
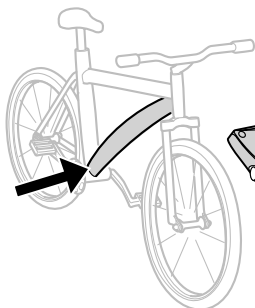

3

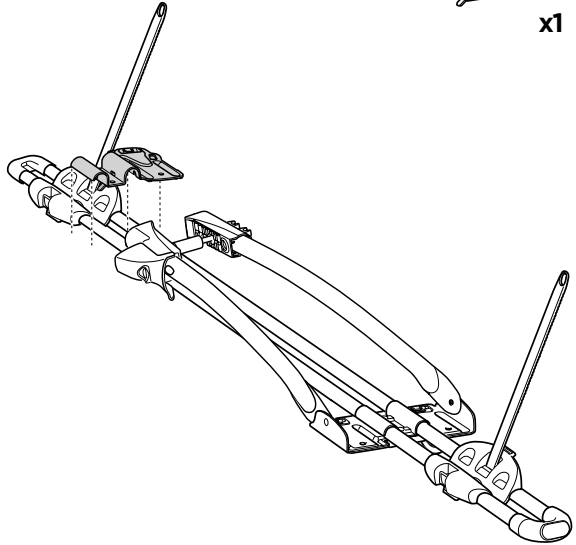
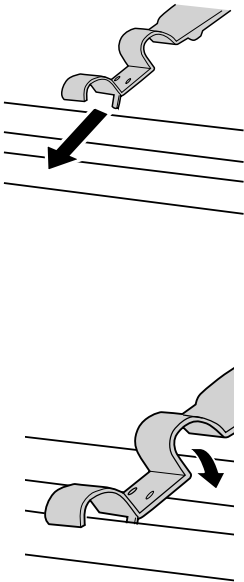

4

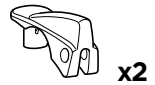
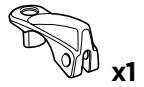
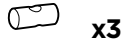
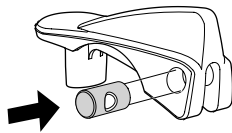
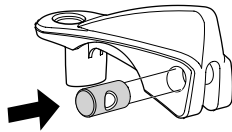

5

i

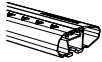

Thule WingBar Evo

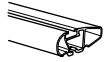

Thule WingBar



x1



x3

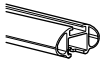

Thule AeroBar



Thule SlideBar



x2

A

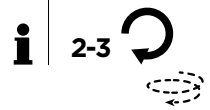
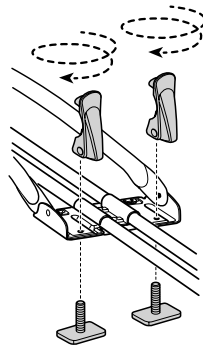
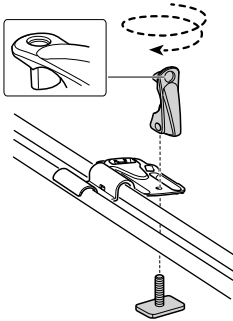

B

i



THULE WingBar Evo

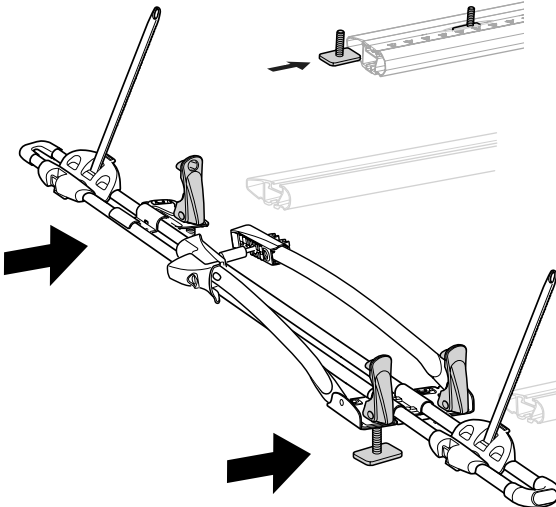
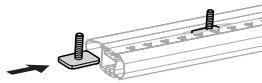

C

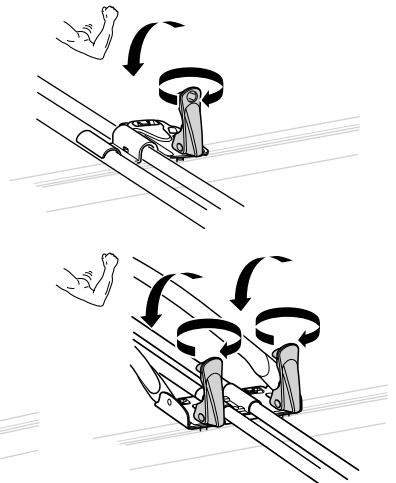

5

i



Thule SquareBar

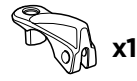

x1



x3



x2



x3

A

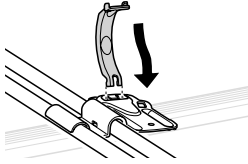

B

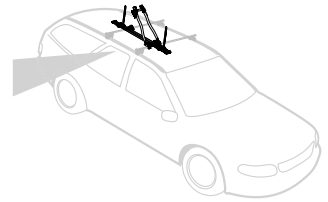
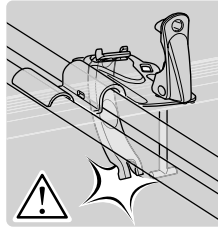
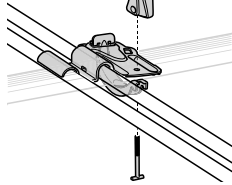
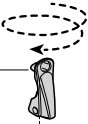
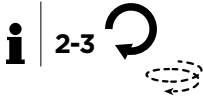

C

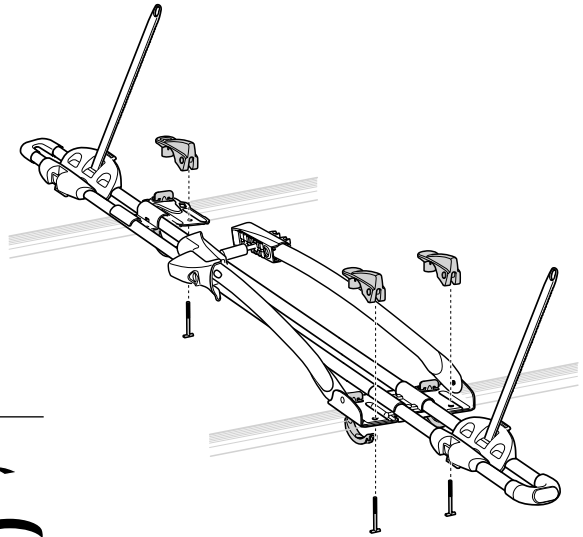
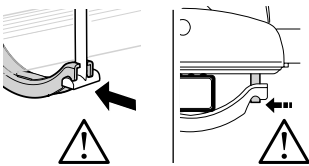

D

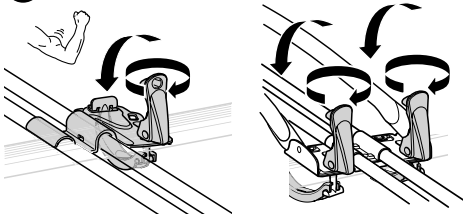

6

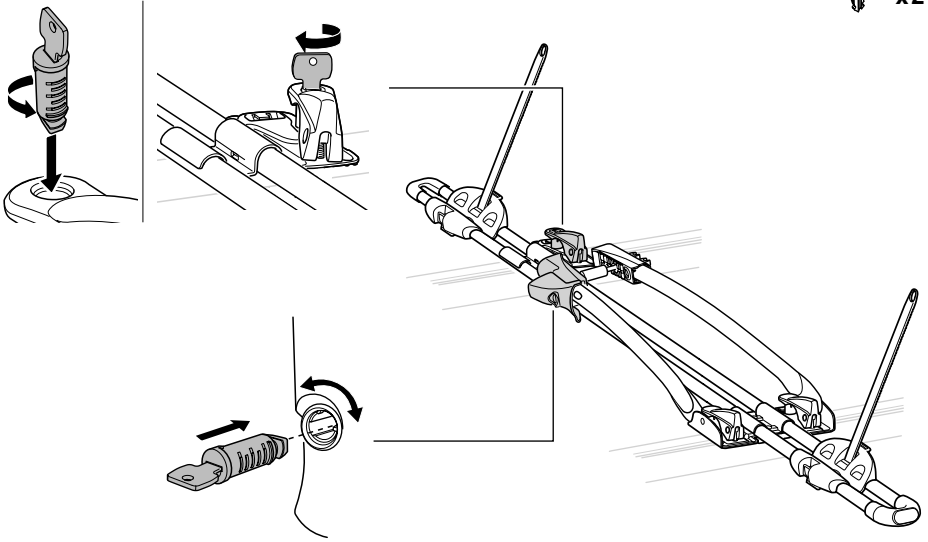

7

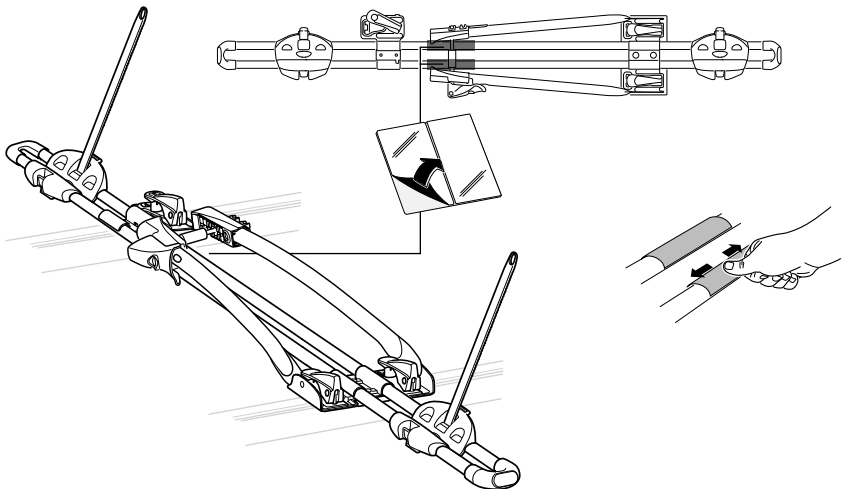
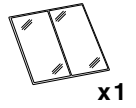

8

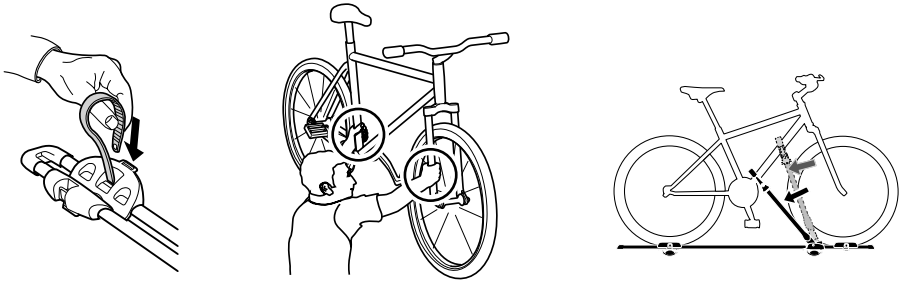

9

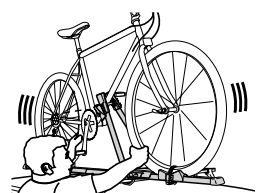
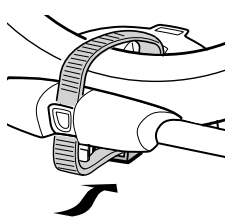
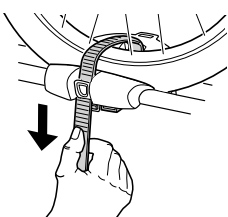
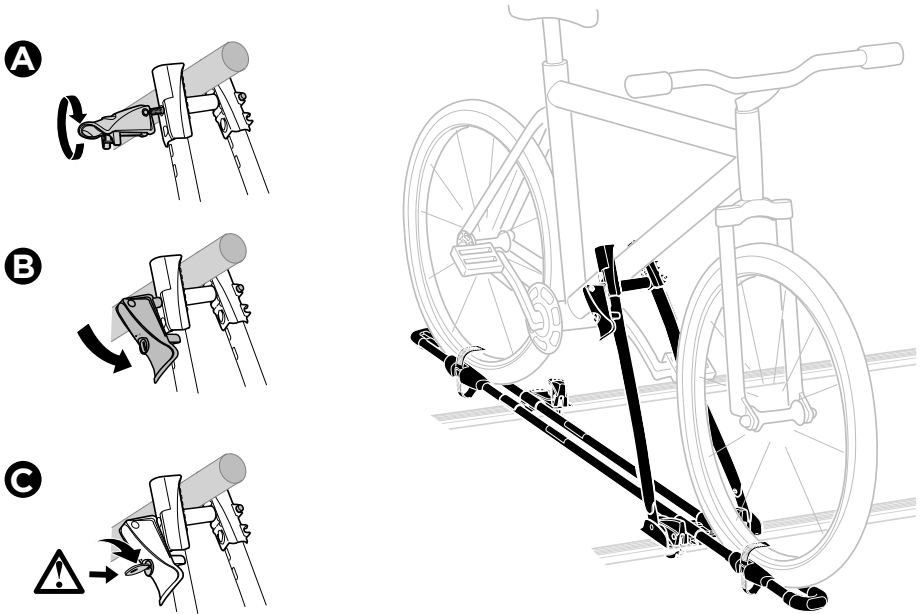

EN Left-hand fitting
FR Montage côté gauche
ES Montaje a izquierda
DE Montage links
NL Montage aan de linker kant
PT Montagem do lado esquerdo
IT Montaggio a sinistra
SV Vänstermonterad
DK Venstremontering
NO Venstremontering
FI Asennus vasemmalle
IS Festing vinstra megin
ET Vasakpoolne kinnitamine
LV Kreisais stiprinājums
LT Kairysis pritvirtinimas
RU Установка на левую сторону
UK Установка на ліву сторону
PL Montaż z lewej

CS Montáž z levé strany
HU Bal oldalról szerelhető
RO Montare pe partea stângă
SK Montáž na ľavej strane
SL Pritrjevanje z leve strani
BG Монтаж отляво
HR Montaža s lijeve strane
EL Τοποθέτηση αριστερά
TR Sol elle montaj
MT Pemasangan kidal

HE התקנה שמאלית
AR التركيب في الجانب الأيسر

ZH (CN) 从左侧安装
ZH (TW) 左側安裝
JA 左手装着
KO 왼손 장착
TH ตัวยึดด้านซ้ายมือ
MS Twañhil bl-id ix-xellugija

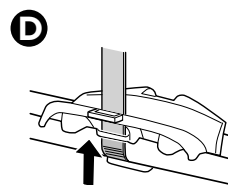
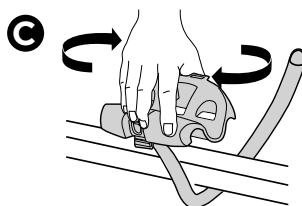
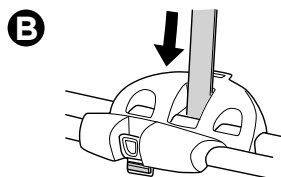
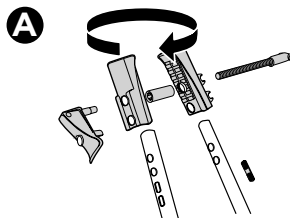
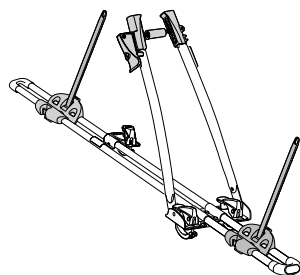

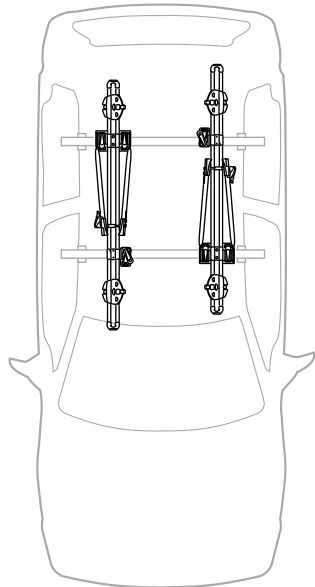
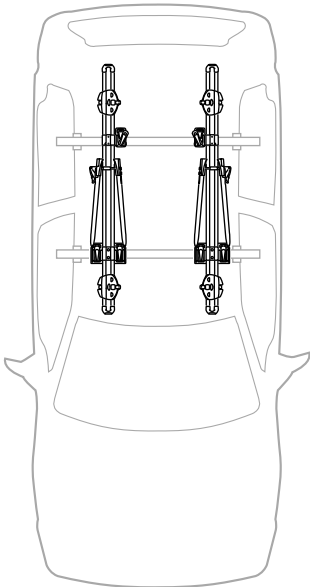
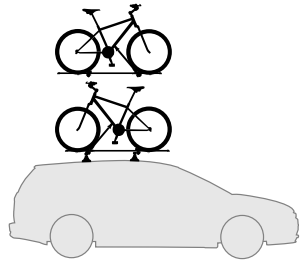
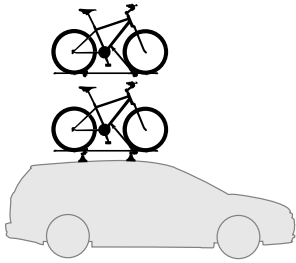

EN Accessories
 FR Accessoires
 ES Accesorios
 DE Zubehör
 NL Accessoires
 PT Acessórios
 IT Accessori
 SV Tillbehör
 DK Tilbehør





NO Tilbehør
 FI Lisävarusteet
 IS Aukabúnaður
 ET Lisavarustus
 LV Piederumi
 LT Priedai
 RU Аксессуары
 UK Аксесуары
 PL Akcesoria

CS Dopřloky
 HU Tartozékok
 RO Accesorii
 SK Príslušenstvo
 SL Dodatki
 BG Принадлежности
 HR Dodaci
 EL Εξαρτήματα
 TR Aksesuarlar

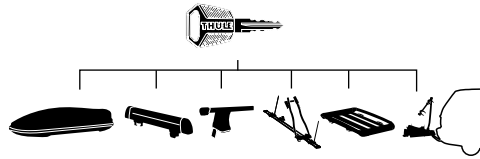
MT Aċċessorji
 HE אביזרים
 AR ملحقات
 ZH (CN) 附件
 ZH (TW) 配件
 JA アクセサリー
 KO 액세서리
 TH อุปกรณ์เสริม
 MS Aksesori

Thule One-Key System



- 450400**  (x4)
- 450600**  (x6)
- 450800**  (x8)
- 451200**  (x12)
- 451600**  (x16)

Thule Adapter 889-3

