



2000 - 2004

CITROEN C-5

Cat. No. **C/017**

e20

e20*94/20*0881*00

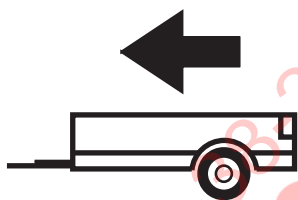

1700kg

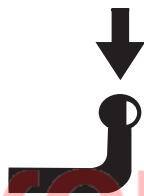

75kg

D = 9,32kN

D (kN) =



MAX kg

x

MAX kg

x 0,00981



MAX kg

+

MAX kg



IMIOLA HAK-POL

96-111 KOWIESY, CHOJNATA 23A, POLAND

Tel. + 48 46 831 73 31, fax +48 831 74 29

e-mail: office@imiola.pl, www.imiola.pl

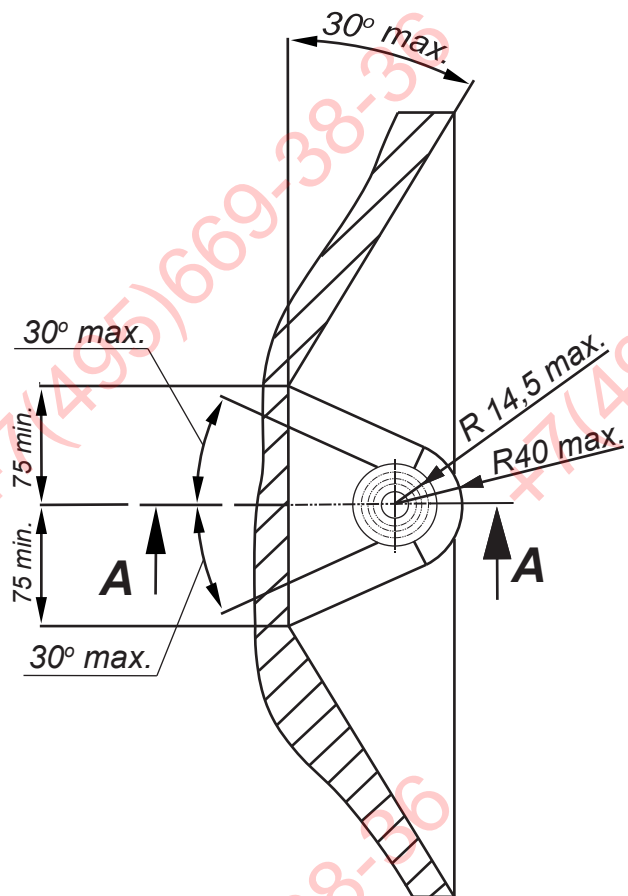

PRZEKRÓJ A-A

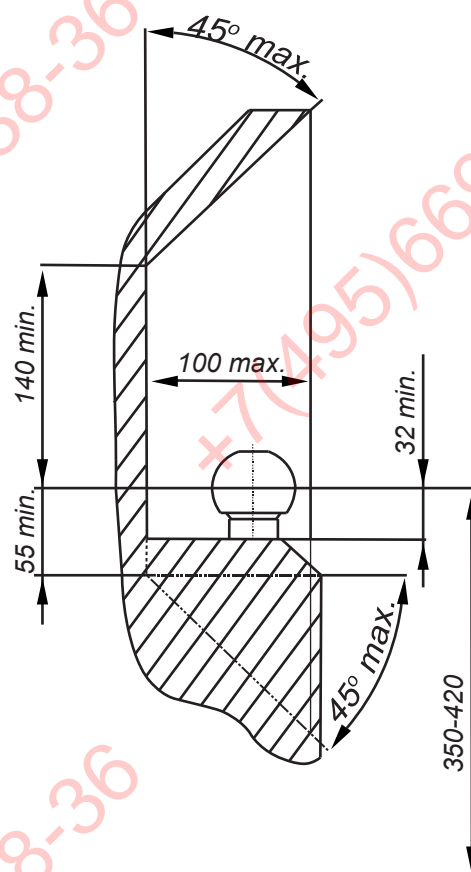

PL Należy zagwarantować przestrzeń swobodną według załącznika VII, rysunek 25a/b Regulaminu EKG ONZ 55.01 przy dopuszczalnym ciężarze całkowitym pojazdu.

F L'espace libre doit être garanti conformément à l'annexe VII, illustration de la réglementation 55.01 CE pour un poids total en charge autorisé du véhicule.







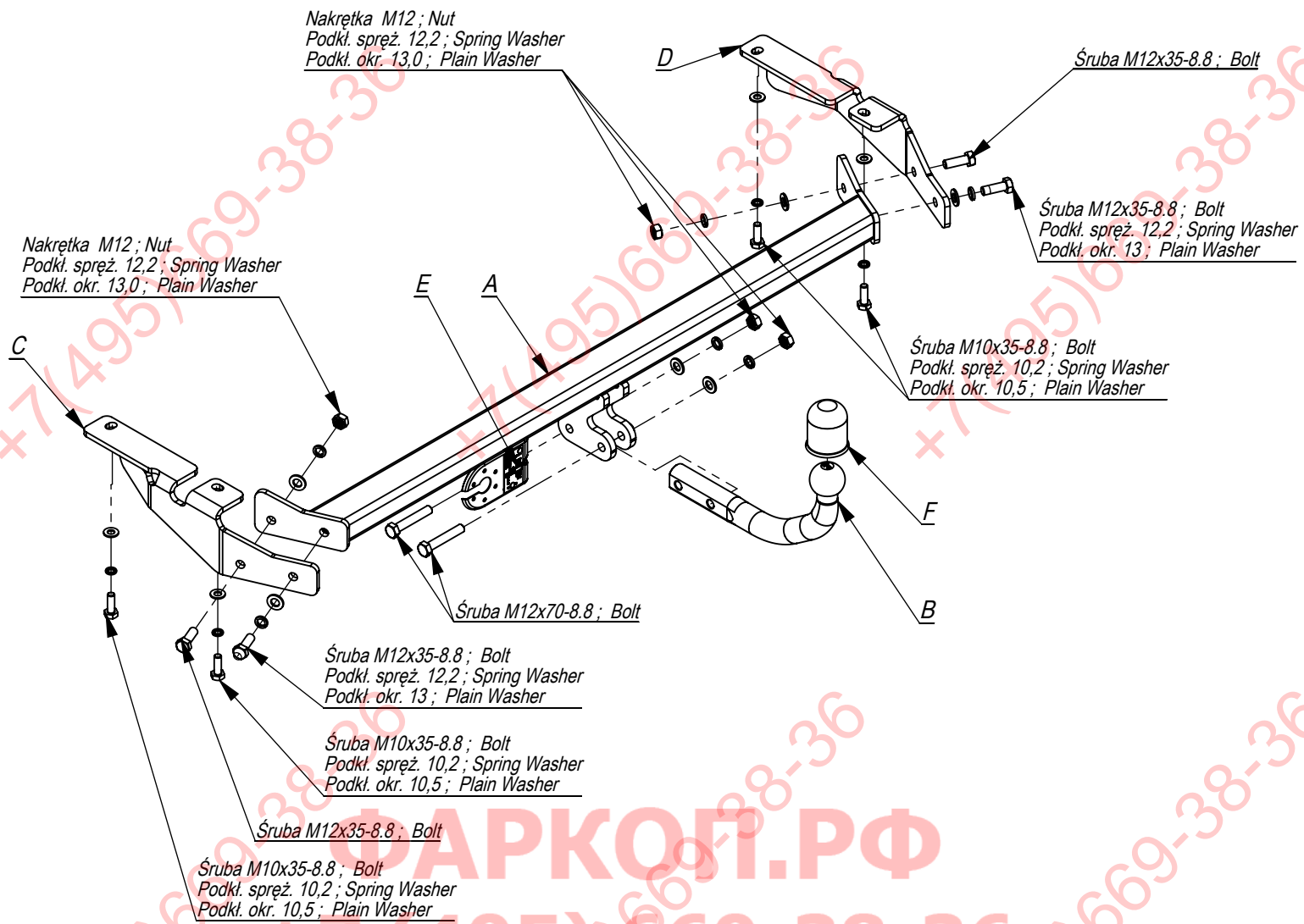

GB The clearance specified in appendix VII, diagram 25a/b of Regulation No. 55.01 UN EU must be guaranteed at laden weight of the vehicle.

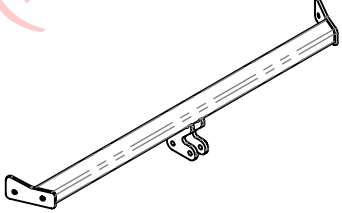
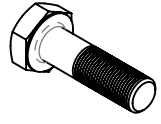
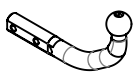
D Der Freiraum nach Anhang VII, Abbildung 25a/b der Vorschriften 55.01 EG ist zu gew 25a/b abzuhalten bei zulässigem Gesamtgewicht des Fahrzeuges.

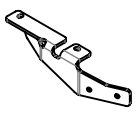
Moment skręcający dla śrub i nakrętek (8.8) Torque settings for nuts and bolts (8.8)	
M8	25Nm
M10	55Nm
M12	85Nm
M14	135Nm
M16	195Nm

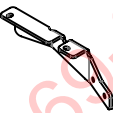



	A	x1		M12x70	2
				M12x35	4
				M10x35	4
	B	x1		M12	4
				13	6
	C	x1		10,5	4
				12,2	6
	D	x1		10,2	4
	E	x1			
	F	x1			

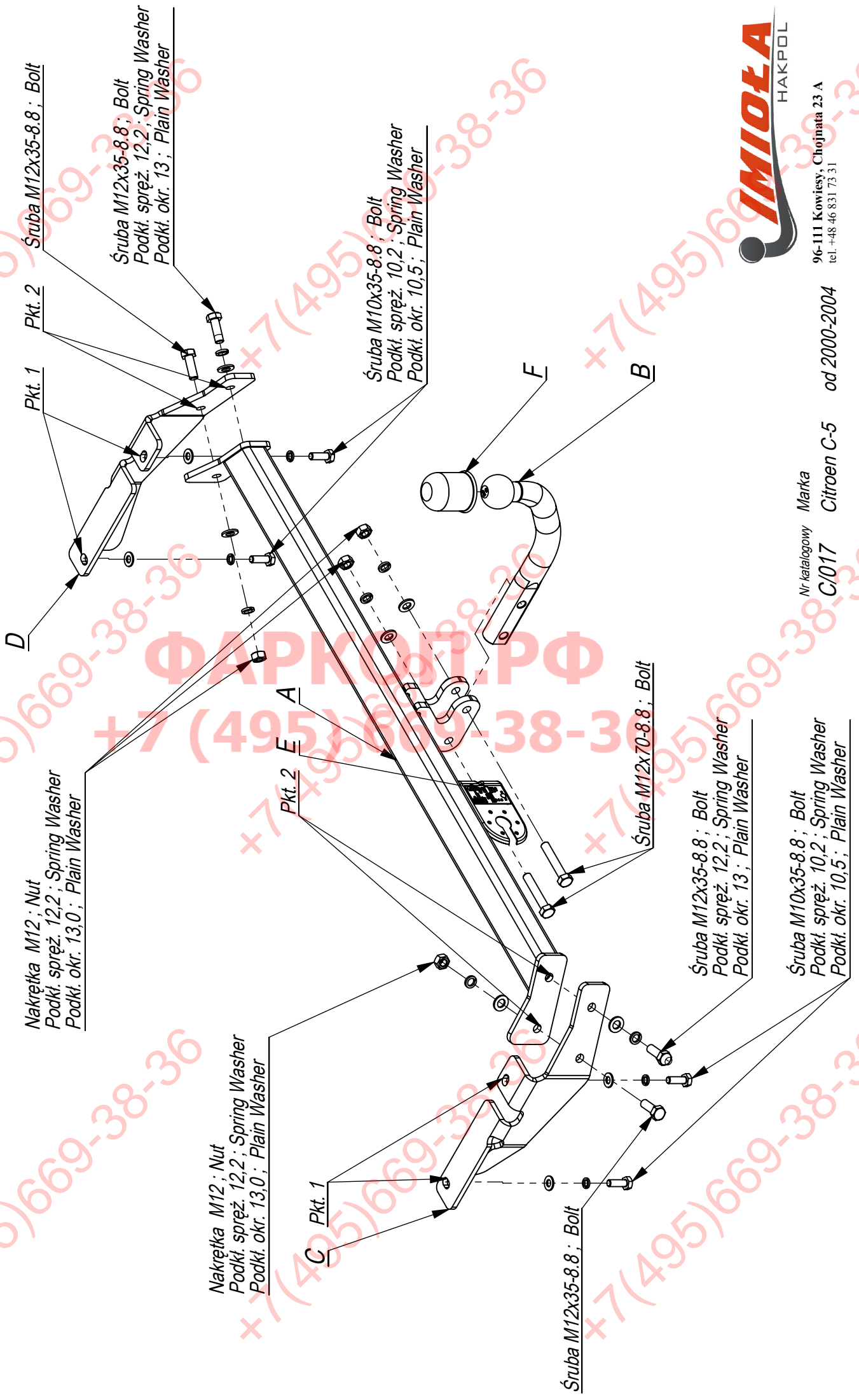

- Udzożnić technologiczne otwory od spodu podłużnic.
- Przykręcić lekko elementy haka C i D śrubami M10x35 8.8 (pkt 1).
- Do elementów haka C i D przykręcić belkę haka A śrubami M12x35 8.8 (pkt 2).
- Przykręcić kulę i blachę gniazda elektrycznego.
- Dokręcić wszystkie śruby z momentem wg tabeli.
- Podłączyć instalację elektryczną.

- The holes of the bottom of the metal clamps make permeable.
- Screw slightly the elements C and D with bolts M10x35 8.8 (point 1).
- Screw the main bar A to the elements C and D with bolts with bolts M12x35 8.8 (point 2).
- Fix the ball and electric plate.
- Tighten all the bolts according to the torque setting- see the table.
- Connect the electric wires.

- Déboucher les ouvertures des longerons partie basse,
- Visser légèrement les éléments C et D de crochet par les boulons M10x35 8.8 (point 1),
- Visser la traverse de crochet A aux éléments C et D de crochet par les boulons M12x35 8.8 (point 2),
- Visser le crochet d'attelage et socle de prise électrique,
- Serrer tous les boulons avec un couple de serrage selon tableau,
- Raccorder le circuit électrique.

- Die vom Werk aus vorhandenen Öffnungen von unten der Längsträger durchlässig machen.
- Die Tragteile C und D mit den Schrauben M10x35 8.8 (Punkt 1) locker anschrauben.
- An die Tragteile C und D den Querbalken A mit den Schrauben M12x35 8.8 (Punkt 2) anschrauben.
- Die Kugel und die Steckdosenhalterung anschrauben.
- Alle Schrauben mit dem in der Tabelle angegebenen Drehmoment festziehen.
- Die Elektroinstallation anschließen.

- Limpiar los orificios en el chasis (punto 1).
- Apretar los elementos C,D en el chasis con tornillos M10x35(p.1).
- Atornillar la viga de la bola de remolque A con los elementos C , usando tornillos M12x35 8.8 (p. 2).
- Apretar todos los tornillos con el par según la tabla anterior.
- Apretar el parachoques.
- Apretar la bola y la placa eléctrica con tornillos M12x70 8.8.
- Conectar la instalación eléctrica.

