

Инструкция по установке

SKODA KAROQ

(2020-)

SKODA KODIAQ

(2017-)

SKODA OCTAVIA











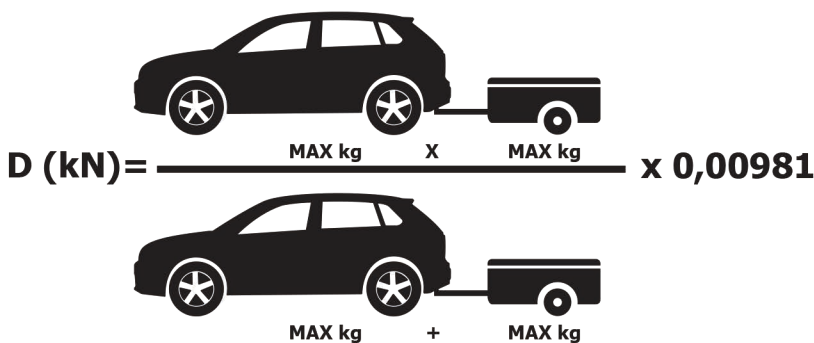







(2012-2020; 2020-)

VOLKSWAGEN TIGUAN

(2016-)



Арт.: F.5111.003

 $D \text{ (kN)} = \frac{\text{MAX kg} \times \text{MAX kg}}{} \times 0,00981$	 <p>2500 kg</p>	 <p>75 kg</p>	<p>D = 12,1 kN</p>														
	<table border="1"> <tr> <td>SKODA KAROQ (2020-)</td> <td></td> <td><input checked="" type="checkbox"/></td> </tr> <tr> <td>SKODA KODIAQ (2017-)</td> <td></td> <td><input checked="" type="checkbox"/></td> </tr> <tr> <td>SKODA OCTAVIA (2012-2020)</td> <td></td> <td><input checked="" type="checkbox"/></td> </tr> <tr> <td>SKODA OCTAVIA (2020-)</td> <td></td> <td><input checked="" type="checkbox"/></td> </tr> <tr> <td>VOLKSWAGEN TIGUAN (2016-)</td> <td></td> <td><input type="checkbox"/></td> </tr> </table>	SKODA KAROQ (2020-)		<input checked="" type="checkbox"/>	SKODA KODIAQ (2017-)		<input checked="" type="checkbox"/>	SKODA OCTAVIA (2012-2020)		<input checked="" type="checkbox"/>	SKODA OCTAVIA (2020-)		<input checked="" type="checkbox"/>	VOLKSWAGEN TIGUAN (2016-)		<input type="checkbox"/>	
SKODA KAROQ (2020-)		<input checked="" type="checkbox"/>															
SKODA KODIAQ (2017-)		<input checked="" type="checkbox"/>															
SKODA OCTAVIA (2012-2020)		<input checked="" type="checkbox"/>															
SKODA OCTAVIA (2020-)		<input checked="" type="checkbox"/>															
VOLKSWAGEN TIGUAN (2016-)		<input type="checkbox"/>															

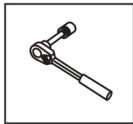

Вкрутить/выкрутить используя инструмент

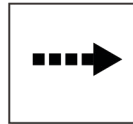

Движение

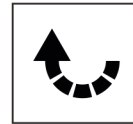

Поворот



Вкрутить/выкрутить не затягивая

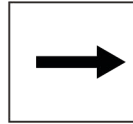

Расположение

Используемый инструмент:

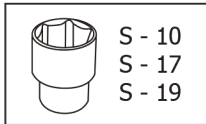
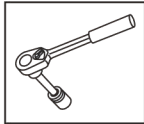

S - 10
S - 17
S - 19

SKODA OCTAVIA
(2012-2020; 2020-)



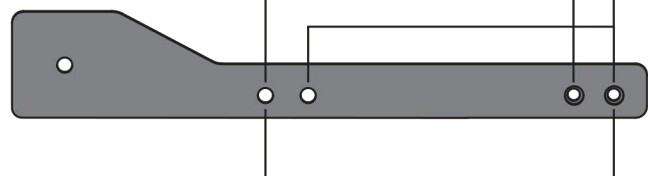





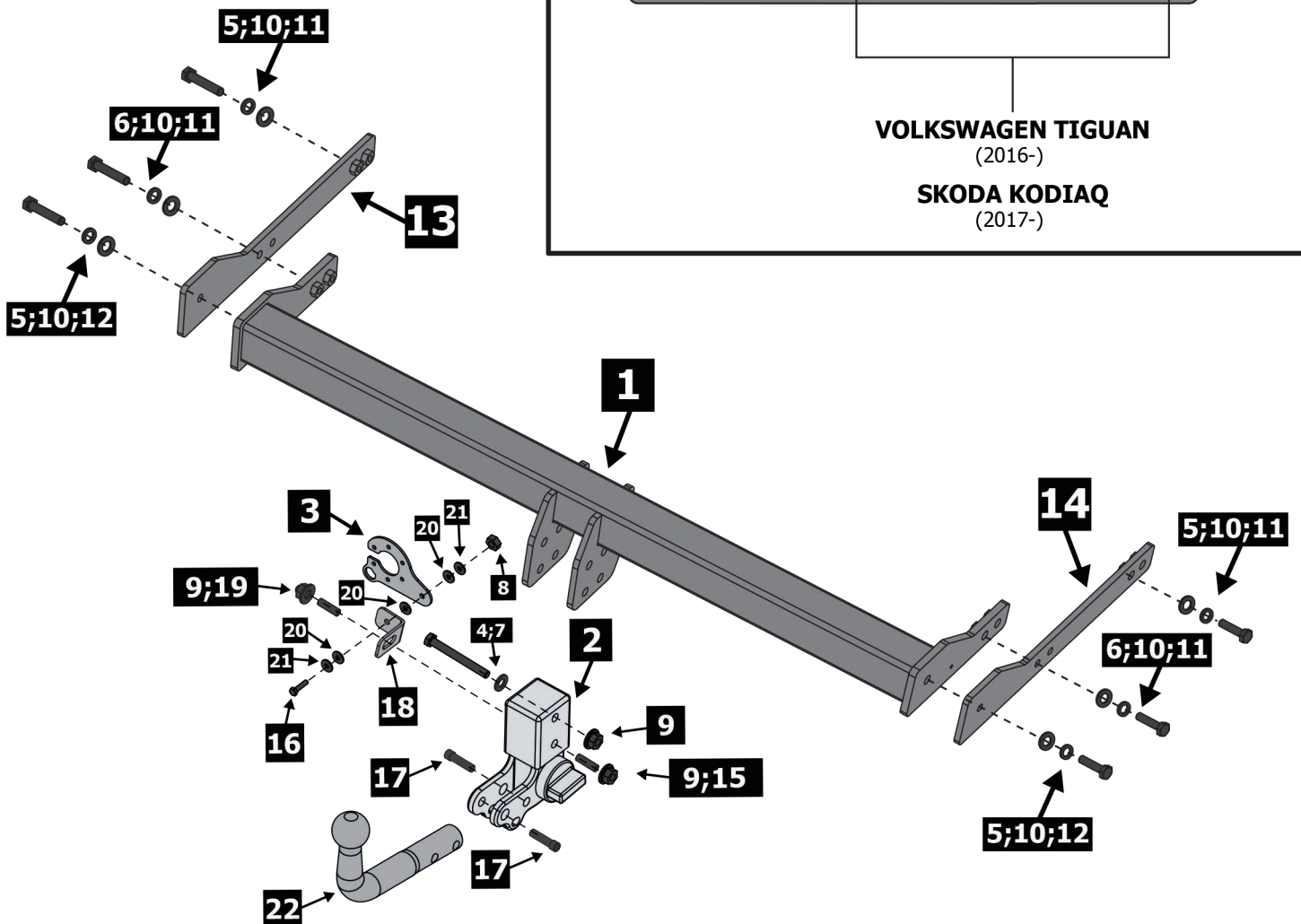

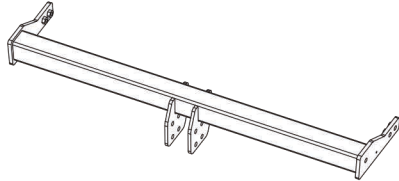
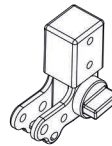

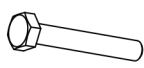
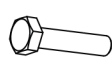
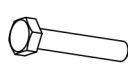



SKODA KAROQ
(2020-)

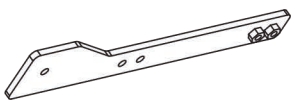
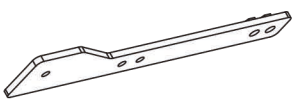

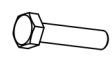
VOLKSWAGEN TIGUAN
(2016-)

SKODA KODIAQ
(2017-)



1	x1	Балка	
2	x1	Быстросъем	
3	x1	Подрозетник	
4	x2	M12x100	
5	x4	M10x40	
6	x2	M10x50	
7	x1	∅ 12	
8	x1	M6	
9	x3	M12	
10	x6	∅ 10	
11	x4	∅ 10	
12	x2	∅ 10	
13	x1	Кронштейн левый	
14	x1	Кронштейн правый	
15	x1	Шпилька M12x35	
16	x1	M6x25	
17	x2	M12x45	
18	x1	Уголок	
19	x1	Шпилька M12x25	
20	x3	∅ 6 (полиамид)	
21	x2	∅ 6	
22	x1	Крюк	

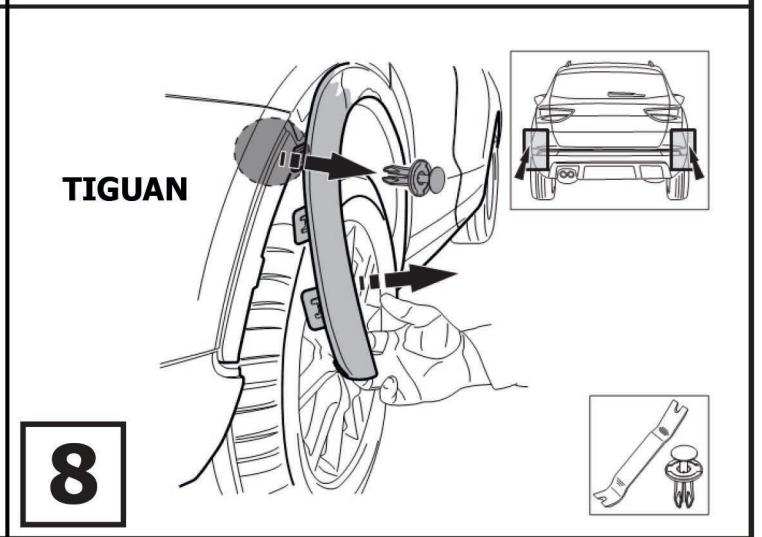
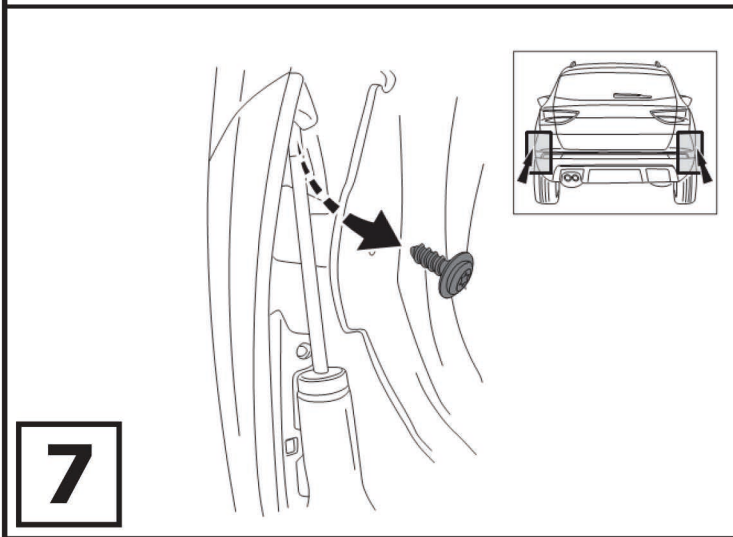
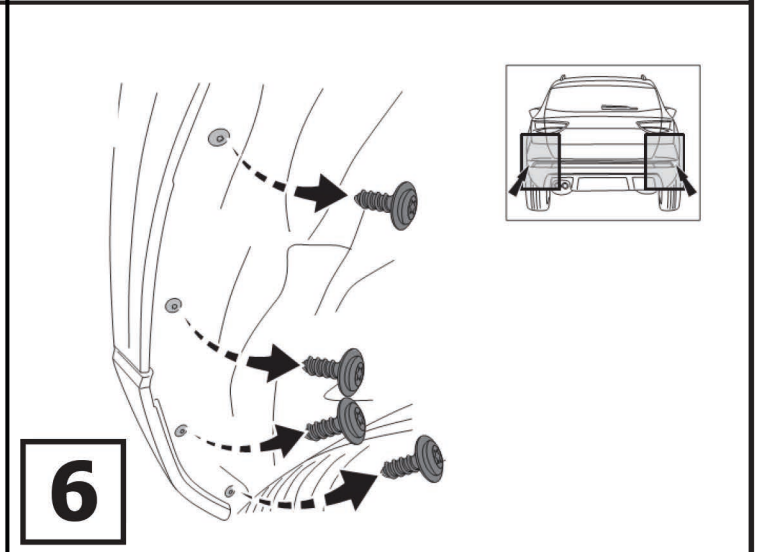
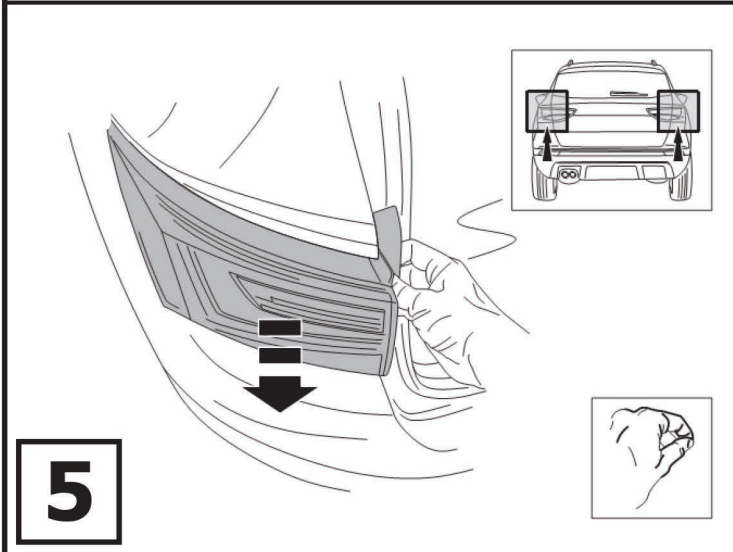
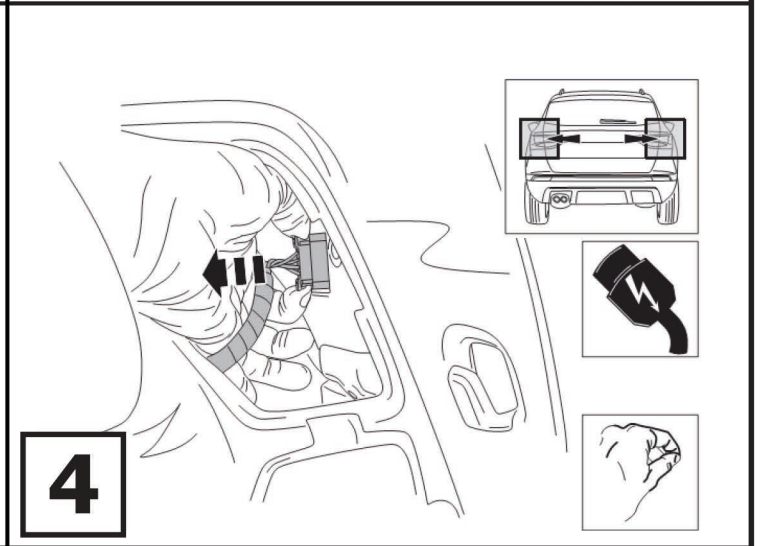
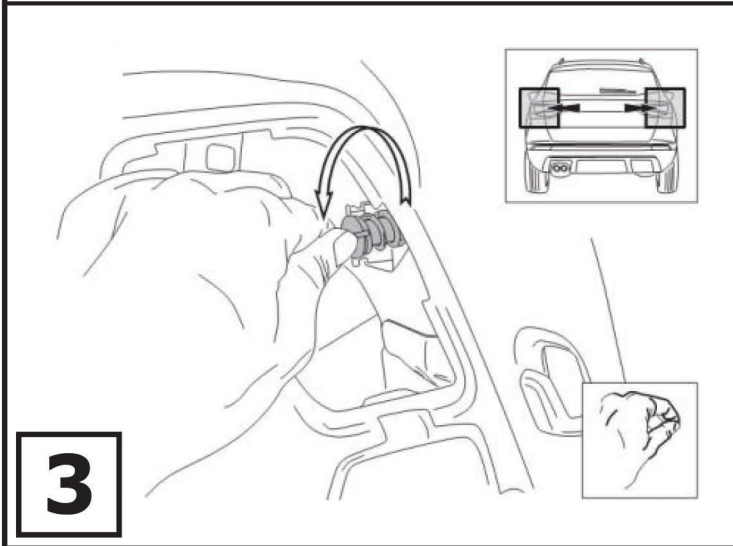
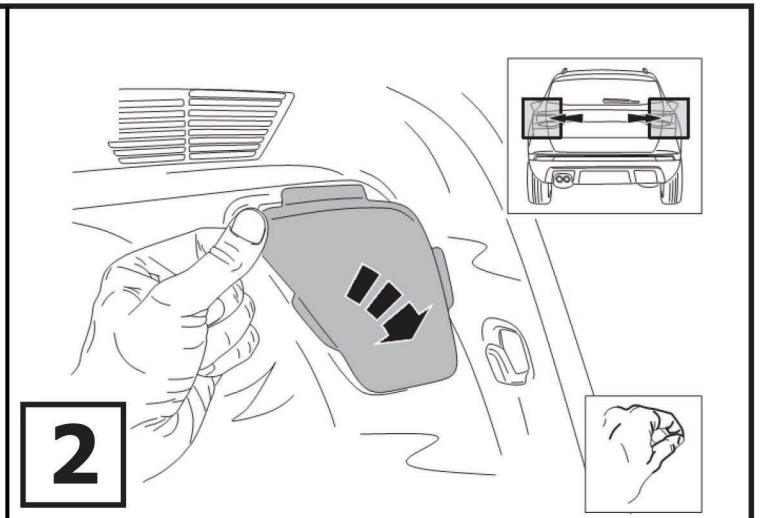
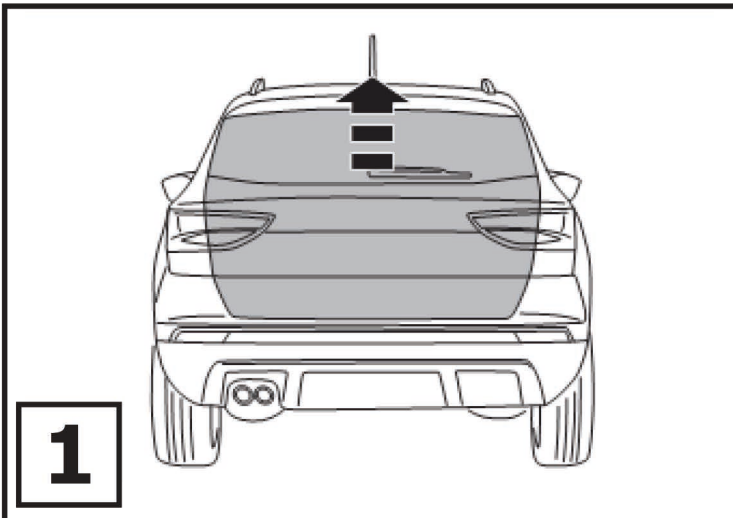

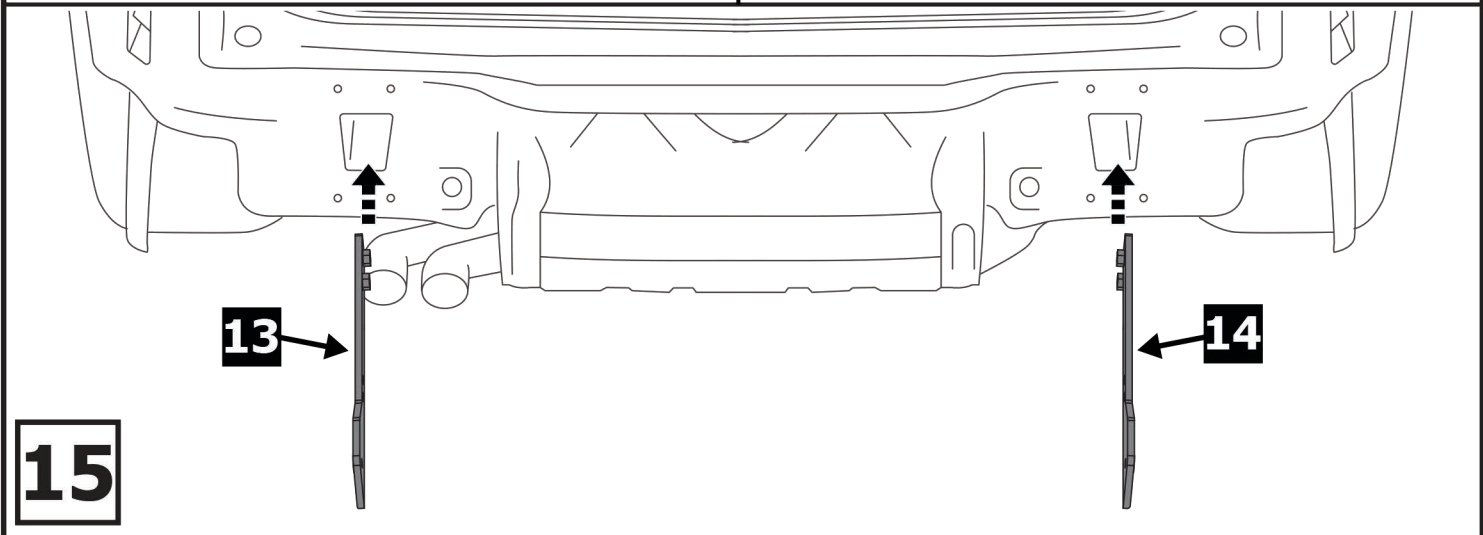
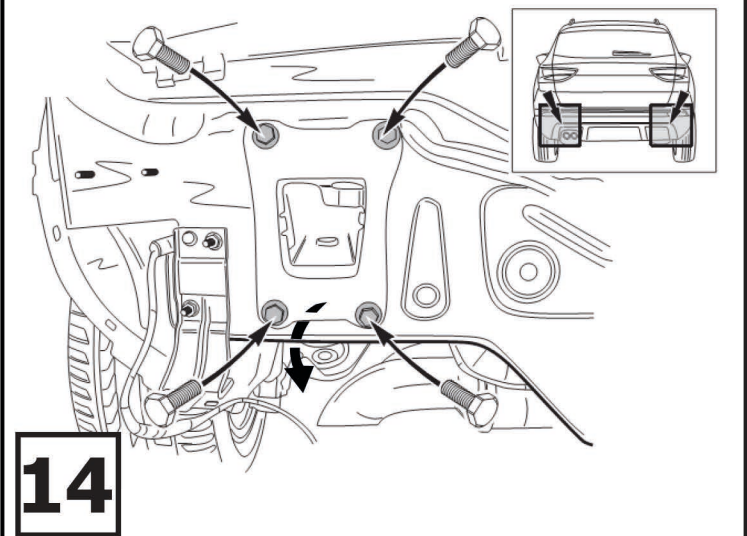
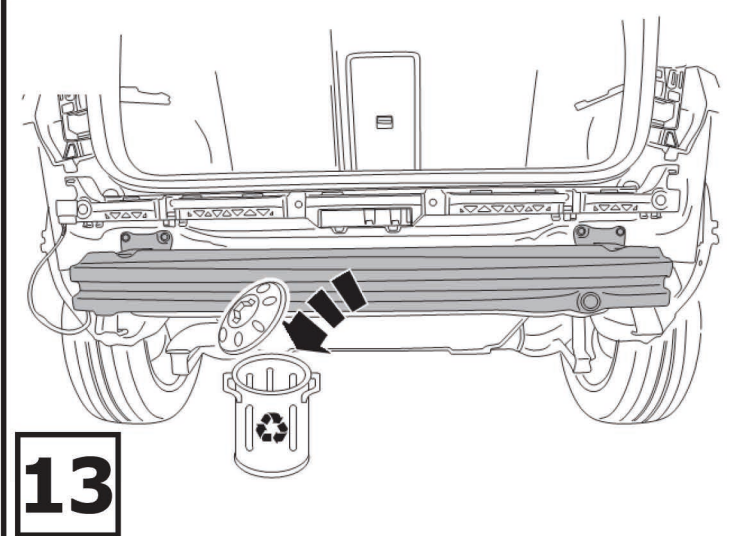
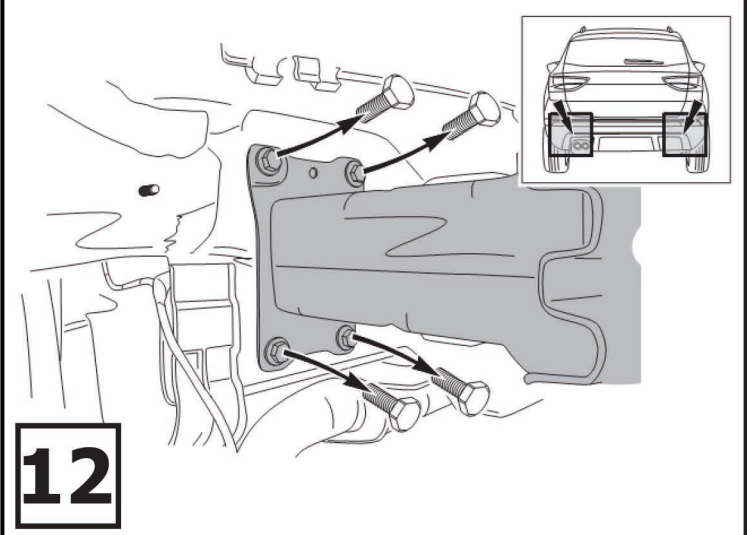
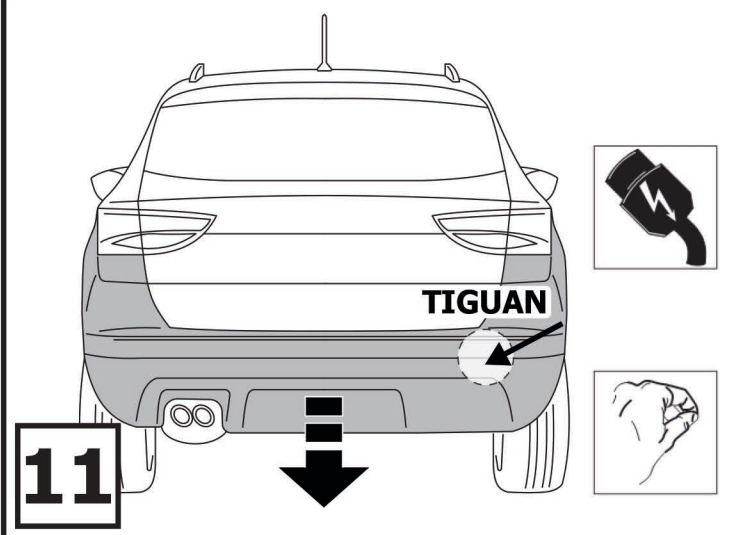
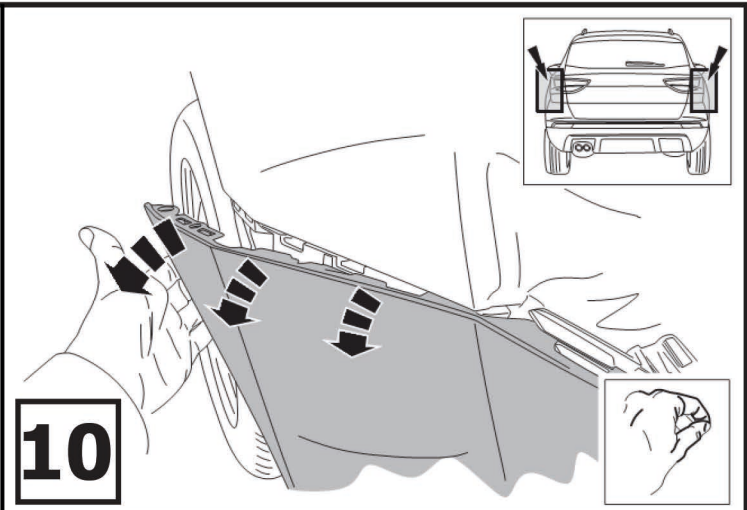
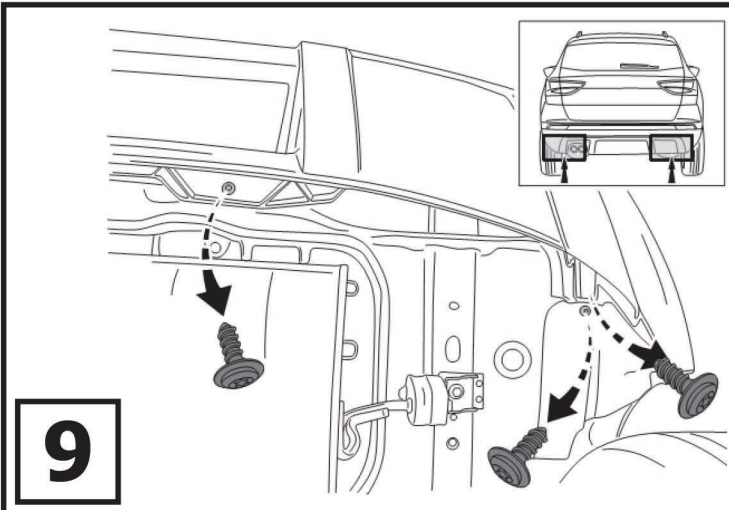

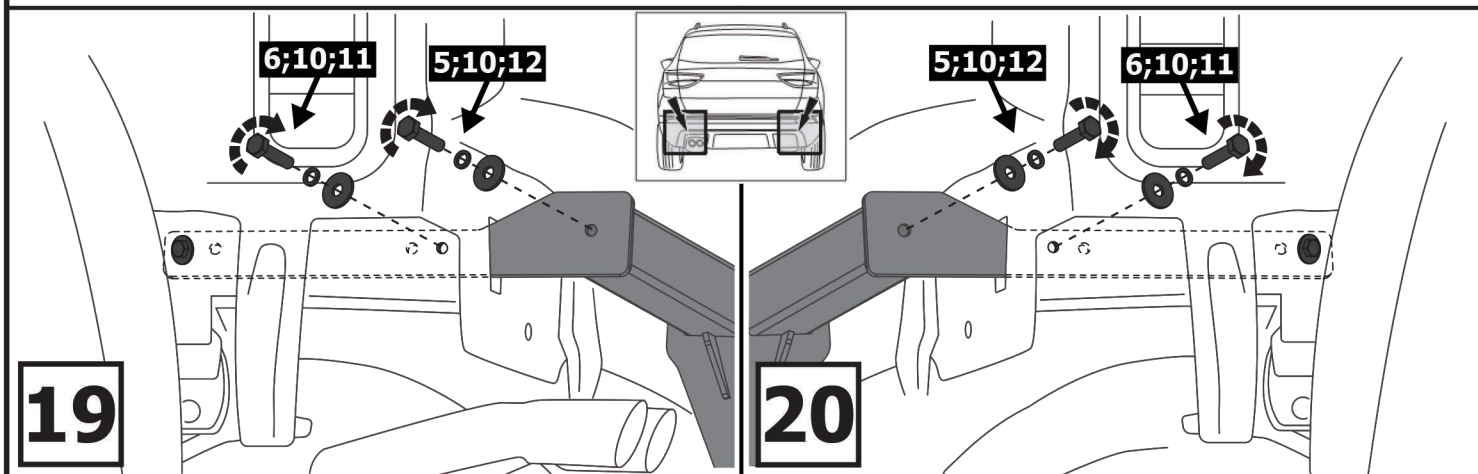
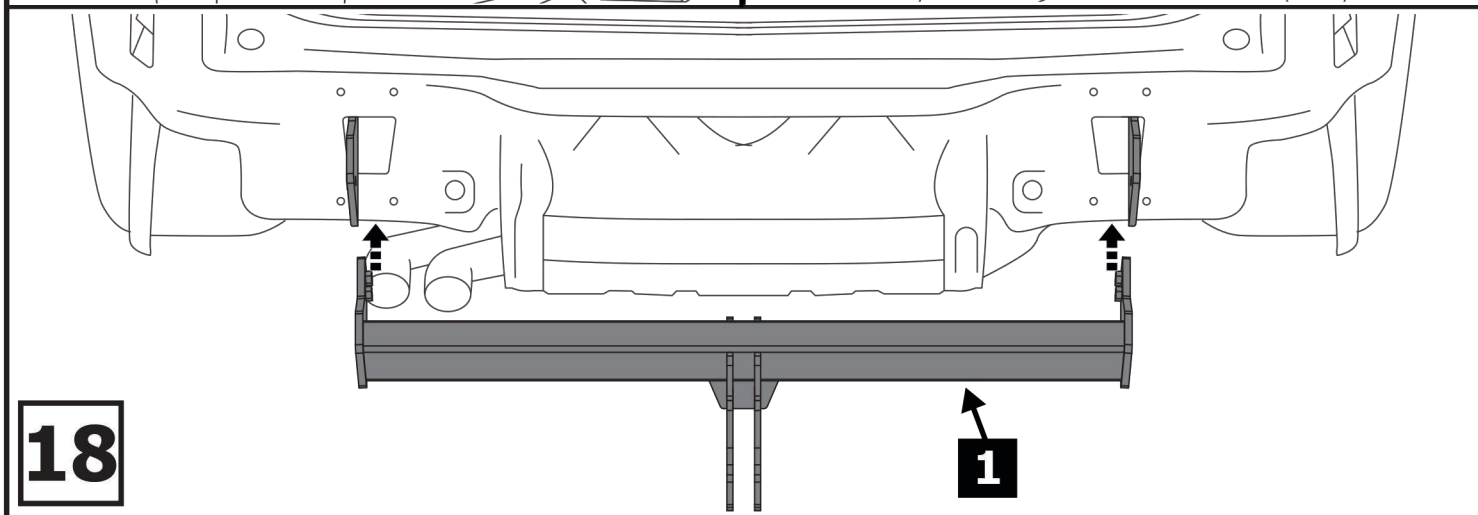
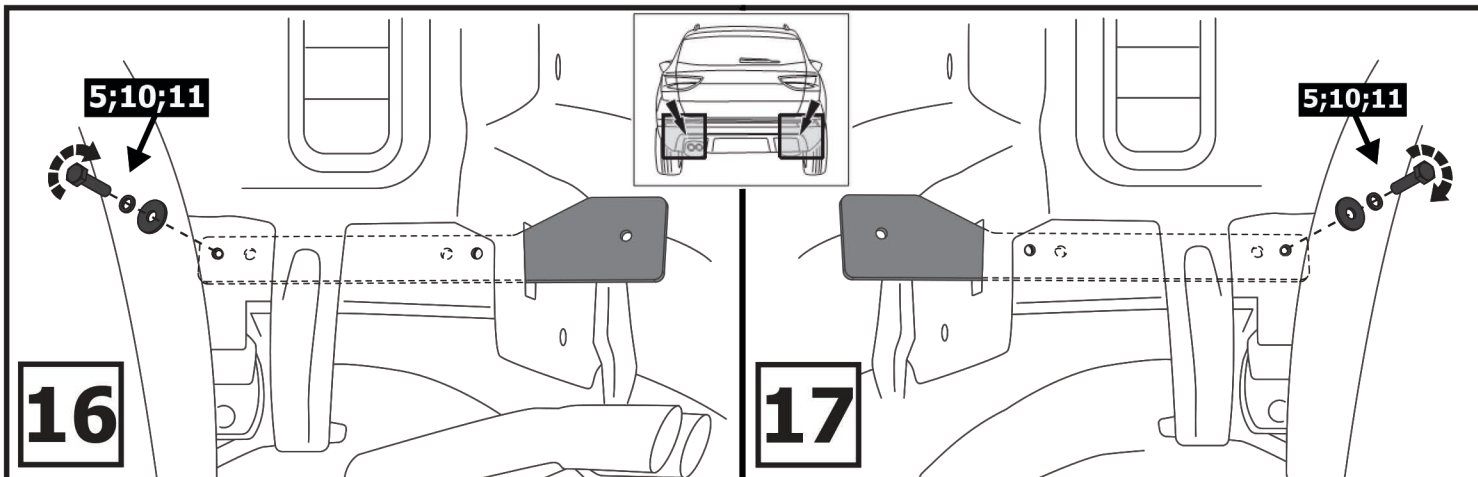

SKODA KAROQ (2020-) ; SKODA KODIAQ (2017-) ; SKODA OCTAVIA (2012-2020; 2020-)

