



# Инструкция по установке

## Toyota Hilux





(2015-)

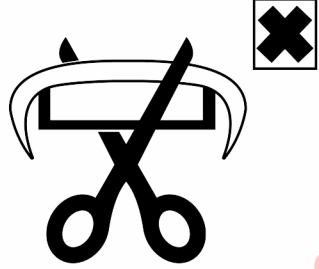

Арт.: F.5718.001

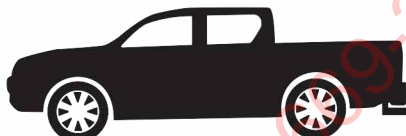
|   |  |                    |   |
|---|--|--------------------|---|
| <br><b>3500 kg</b> | <br><b>120 kg</b> | <b>D = 15,6 kN</b> |  |
|---|--|--------------------|---|

**D (kN) =**

|   |               |          |  |               |
|---|---------------|----------|--|---------------|
|  | <b>MAX kg</b> | <b>X</b> |  | <b>MAX kg</b> |
| <hr/>   |               |          |  |               |
|  | <b>MAX kg</b> | <b>+</b> |  | <b>MAX kg</b> |

**x 0,00981**

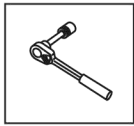

Вкрутить/выкрутить используя инструмент

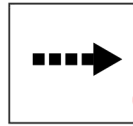

Движение

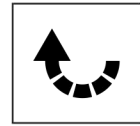

Поворот



Вкрутить/выкрутить не затягивая

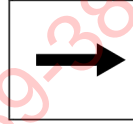





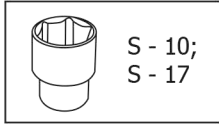
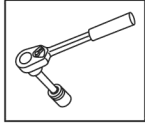

Расположение

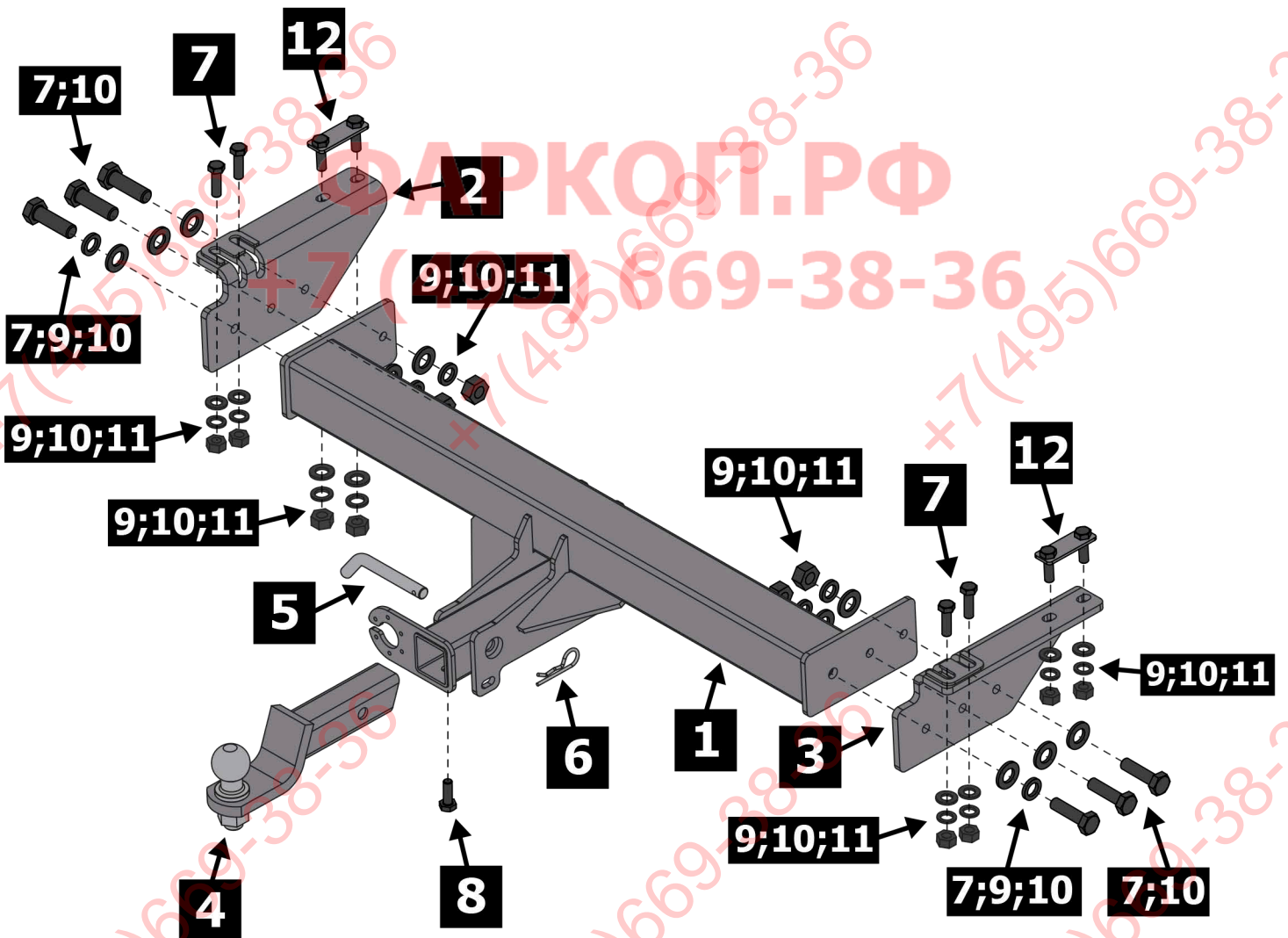
### Используемый инструмент:

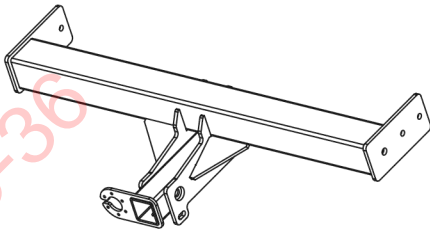
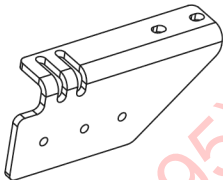
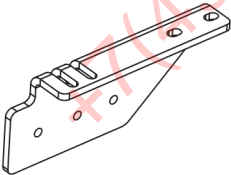
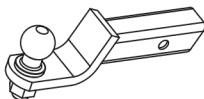

S - 10;  
S - 17

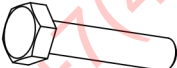

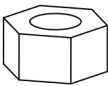
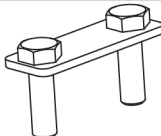
|           |     |                    |   |
|-----------|-----|--------------------|---|
| <b>1</b>  | x1  | Балка              |      |
| <b>2</b>  | x1  | Кронштейн правый   |    |
| <b>3</b>  | x1  | Кронштейн левый    |    |
| <b>4</b>  | x1  | Крюк               |    |
| <b>5</b>  | x1  |                    |    |
| <b>6</b>  | x1  |                    |   |
| <b>7</b>  | x10 | M12x1,25x40        |  |
| <b>8</b>  | x1  | M10x20             |  |
| <b>9</b>  | x14 | ∅ 12               |  |
| <b>10</b> | x22 | ∅ 12               |  |
| <b>11</b> | x12 | M12x1,25           |  |
| <b>12</b> | x2  | Закладная пластина |  |

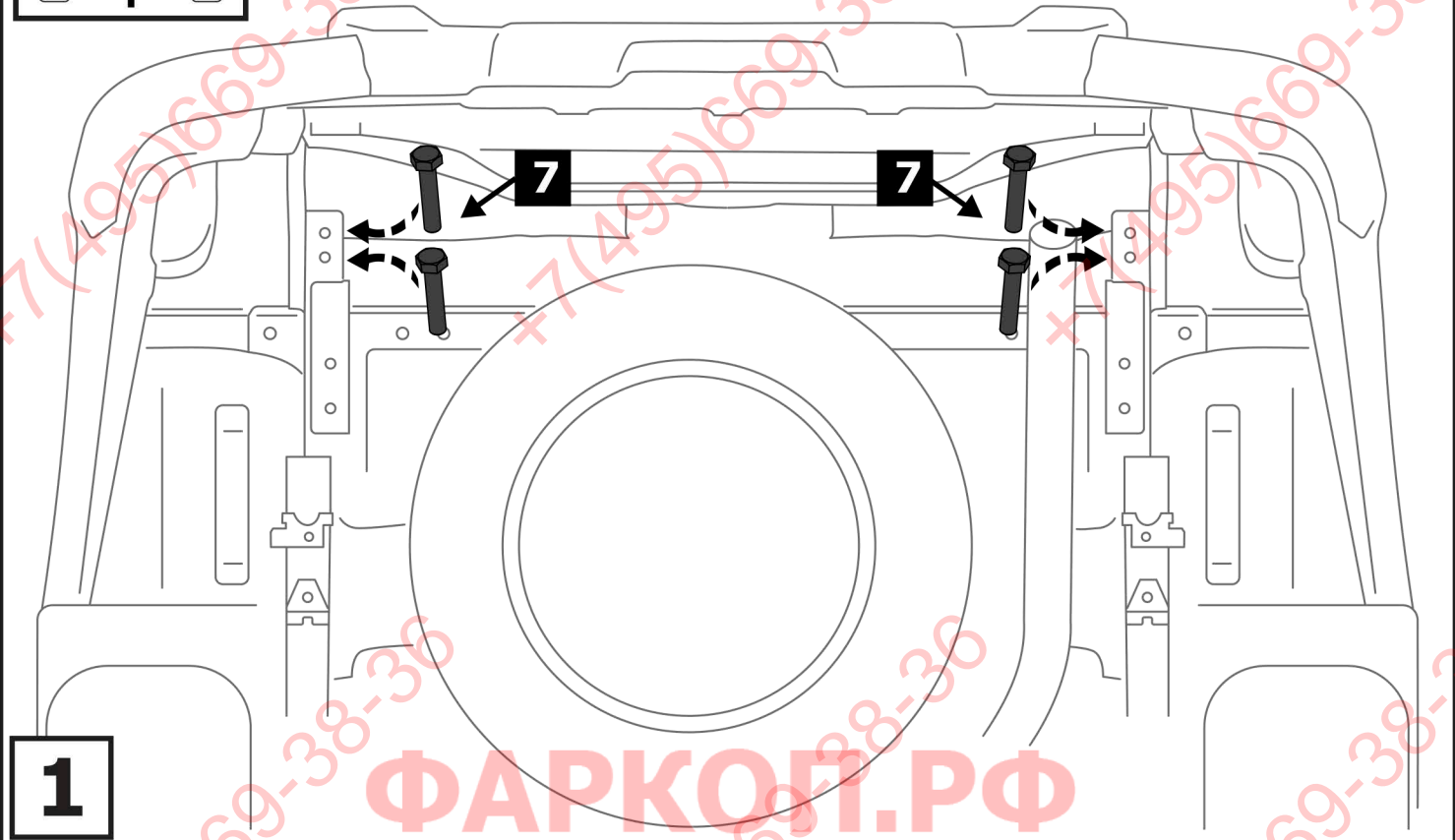
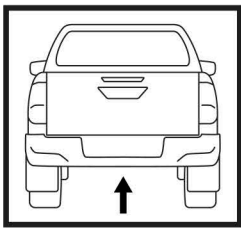

**1**

ФАРКОП.РФ

+7 (495) 669-38-36

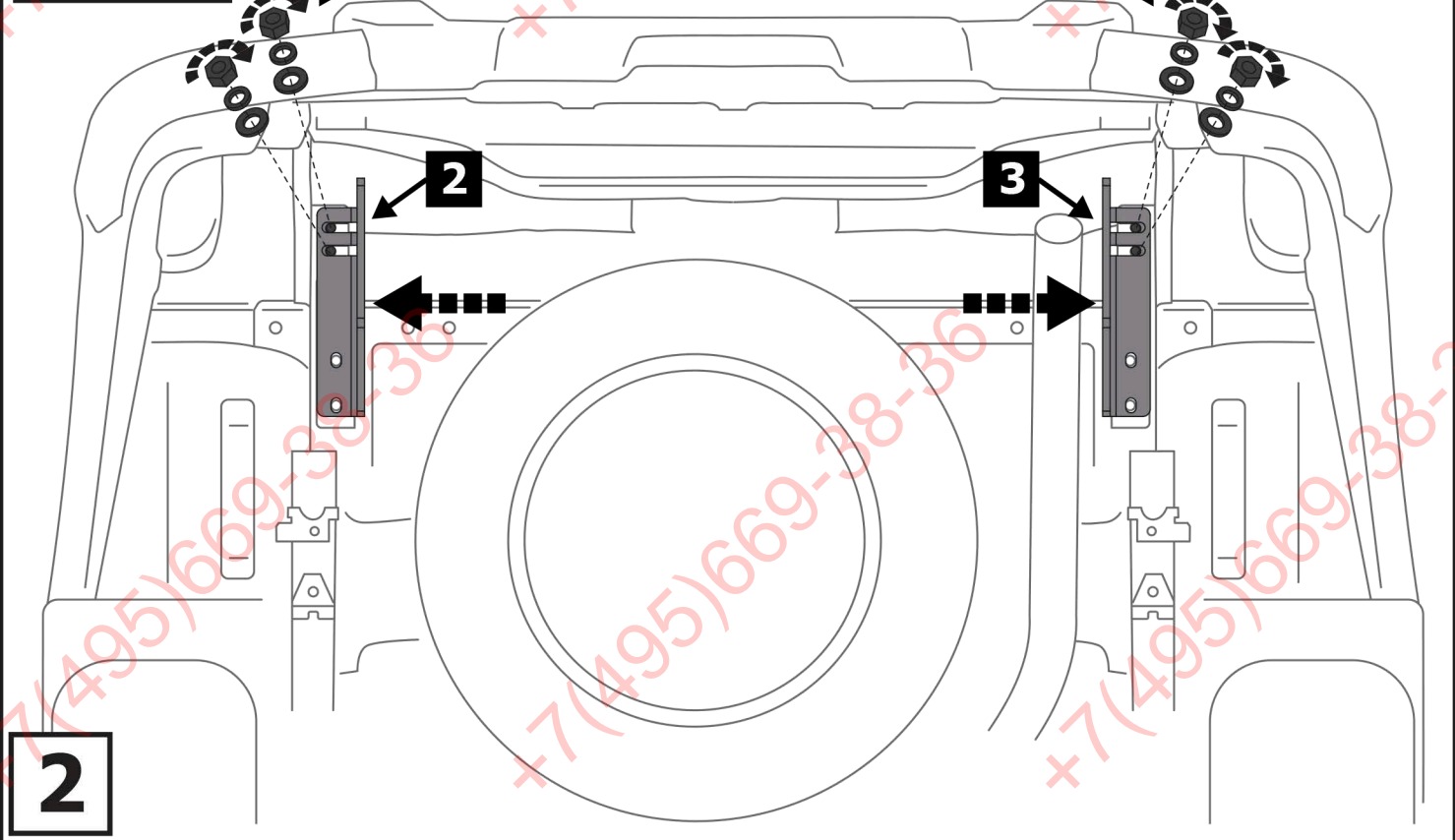
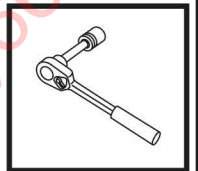
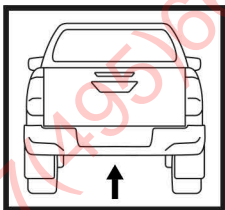

**2**

9;10;11

9;10;11

