





# Инструкция по установке **LADA Granta HB** (2019-)



Арт.: F.6013.009

 <p>1100 kg</p>	 <p>75 kg</p>	 $D \text{ (kN)} = \frac{\text{MAX kg} \times \text{MAX kg}}{\text{MAX kg} + \text{MAX kg}} \times 0,00981$
<p><math>D = 6,33 \text{ kN}</math></p>		

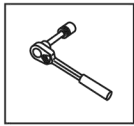

Вкрутить/выкрутить используя инструмент

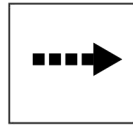

Движение

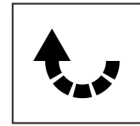

Поворот



Вкрутить/выкрутить не затягивая

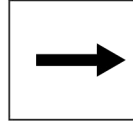





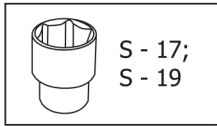
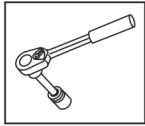

Расположение

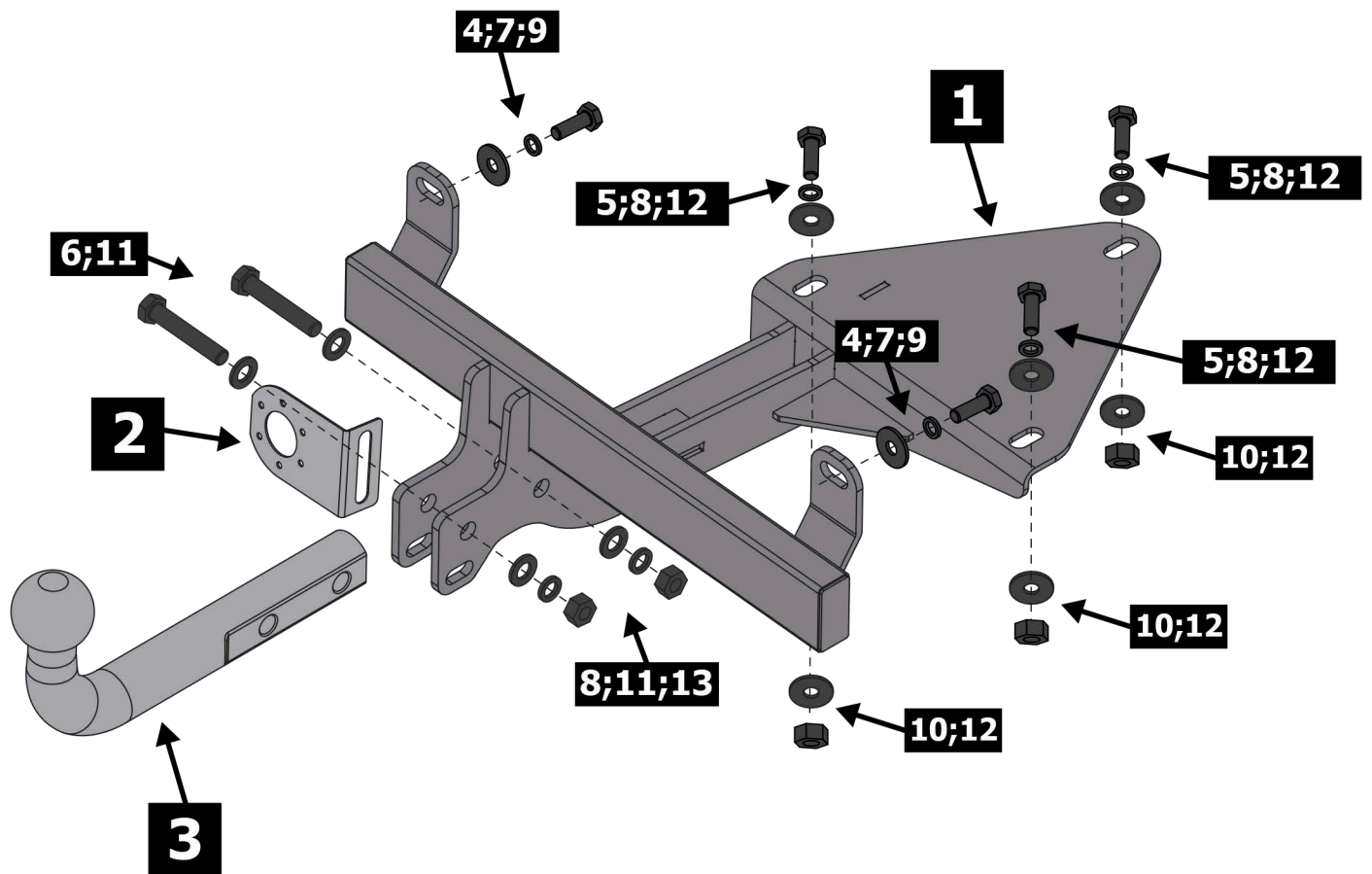
## Используемый инструмент:

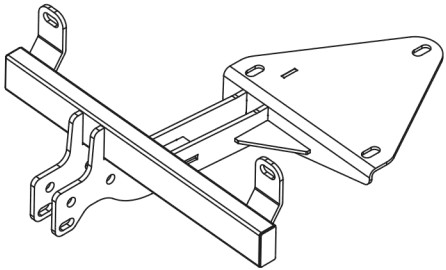
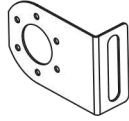
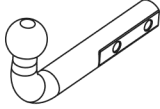
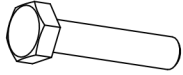
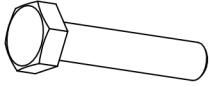
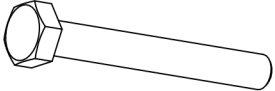

S - 17;  
S - 19

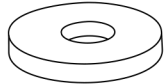

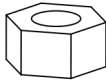
<b>1</b>	x1	Балка	
<b>2</b>	x1	Подрозетник	
<b>3</b>	x1	Крюк	
<b>4</b>	x2	M10x1.25x25	
<b>5</b>	x3	M12x30	
<b>6</b>	x2	M12x1.25x70	
<b>7</b>	x2	∅ 10	
<b>8</b>	x5	∅ 12	
<b>9</b>	x2	∅ 10	
<b>10</b>	x6	∅ 12	
<b>11</b>	x4	∅ 12	
<b>12</b>	x3	M12	
<b>13</b>	x2	M12x1.25	

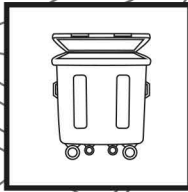
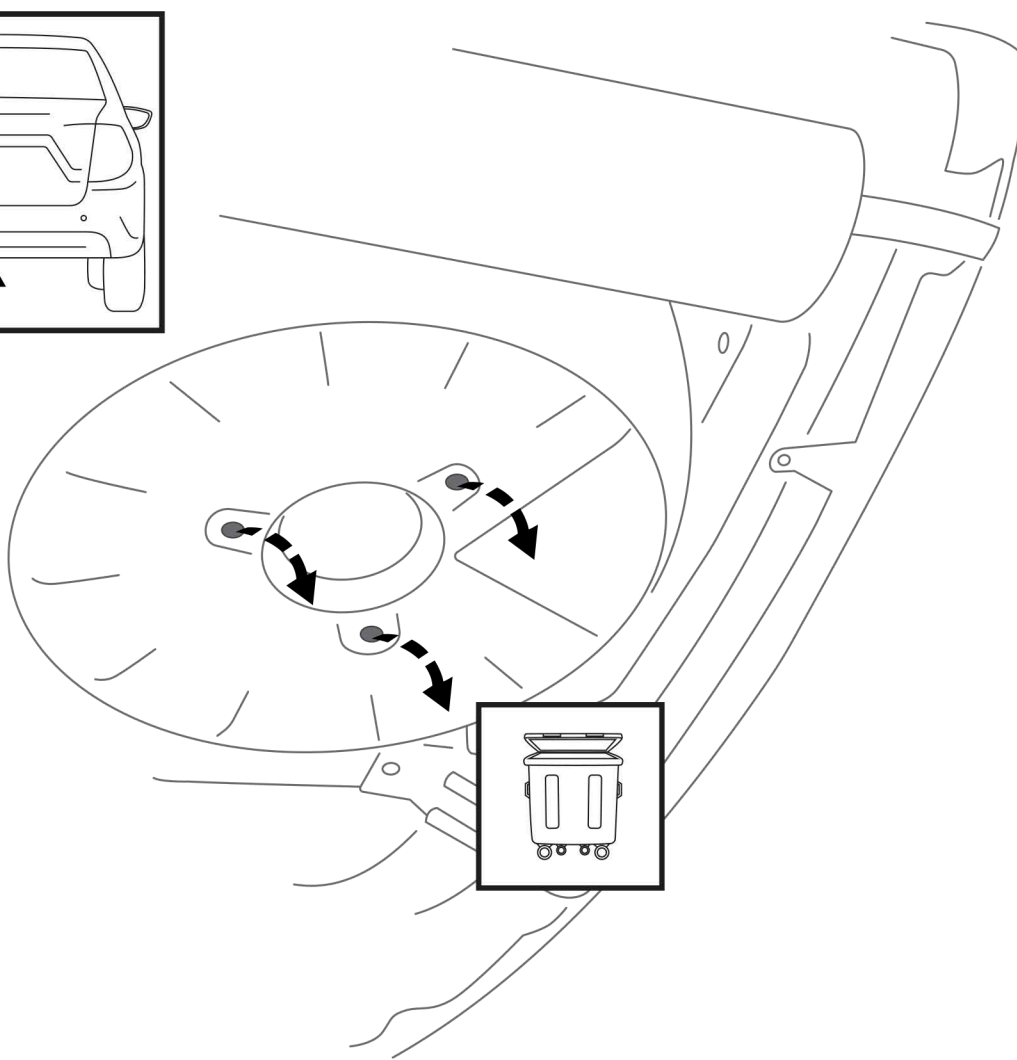
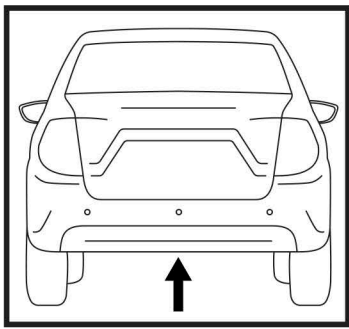

**1**

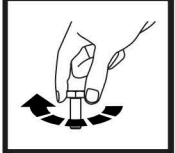
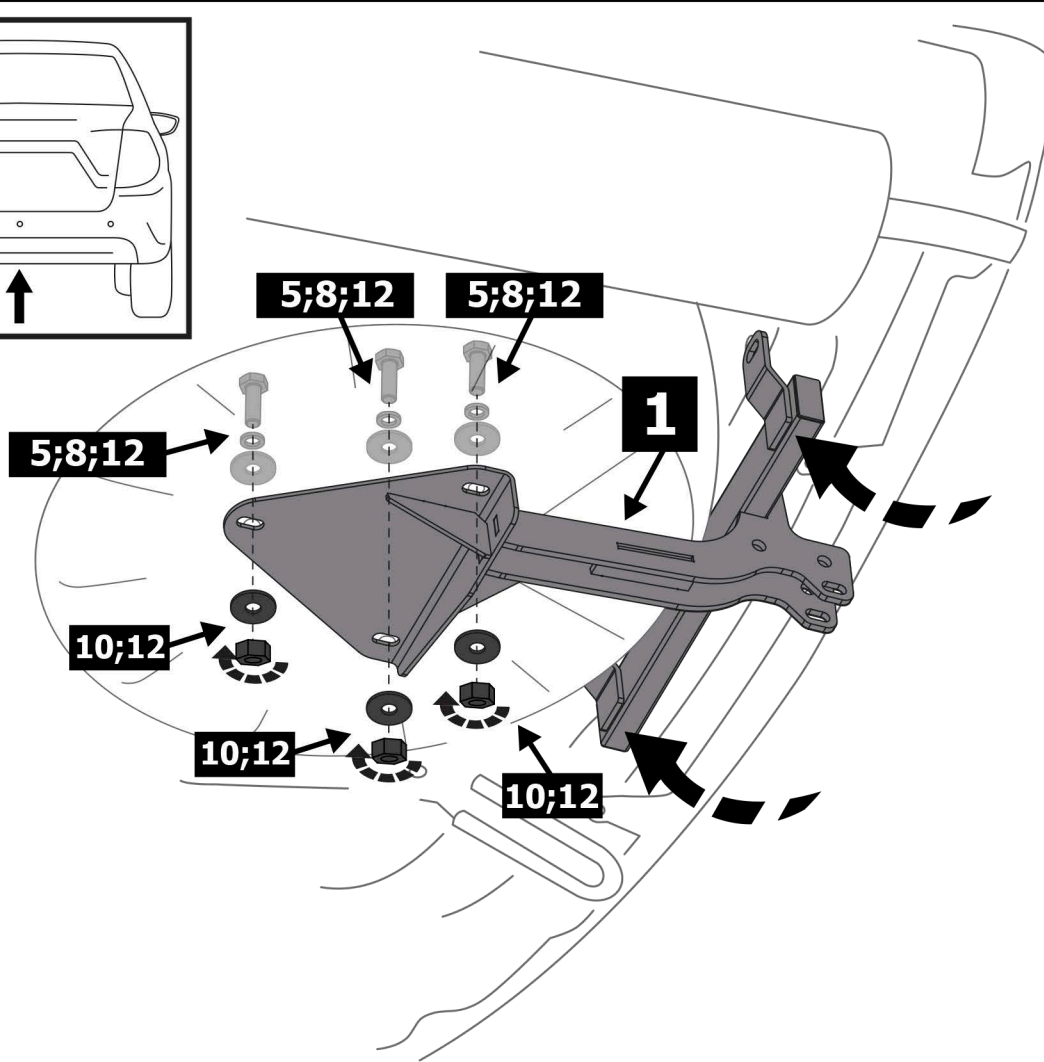
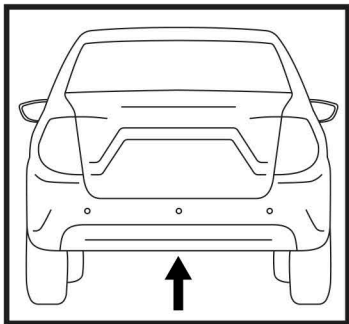

**2**

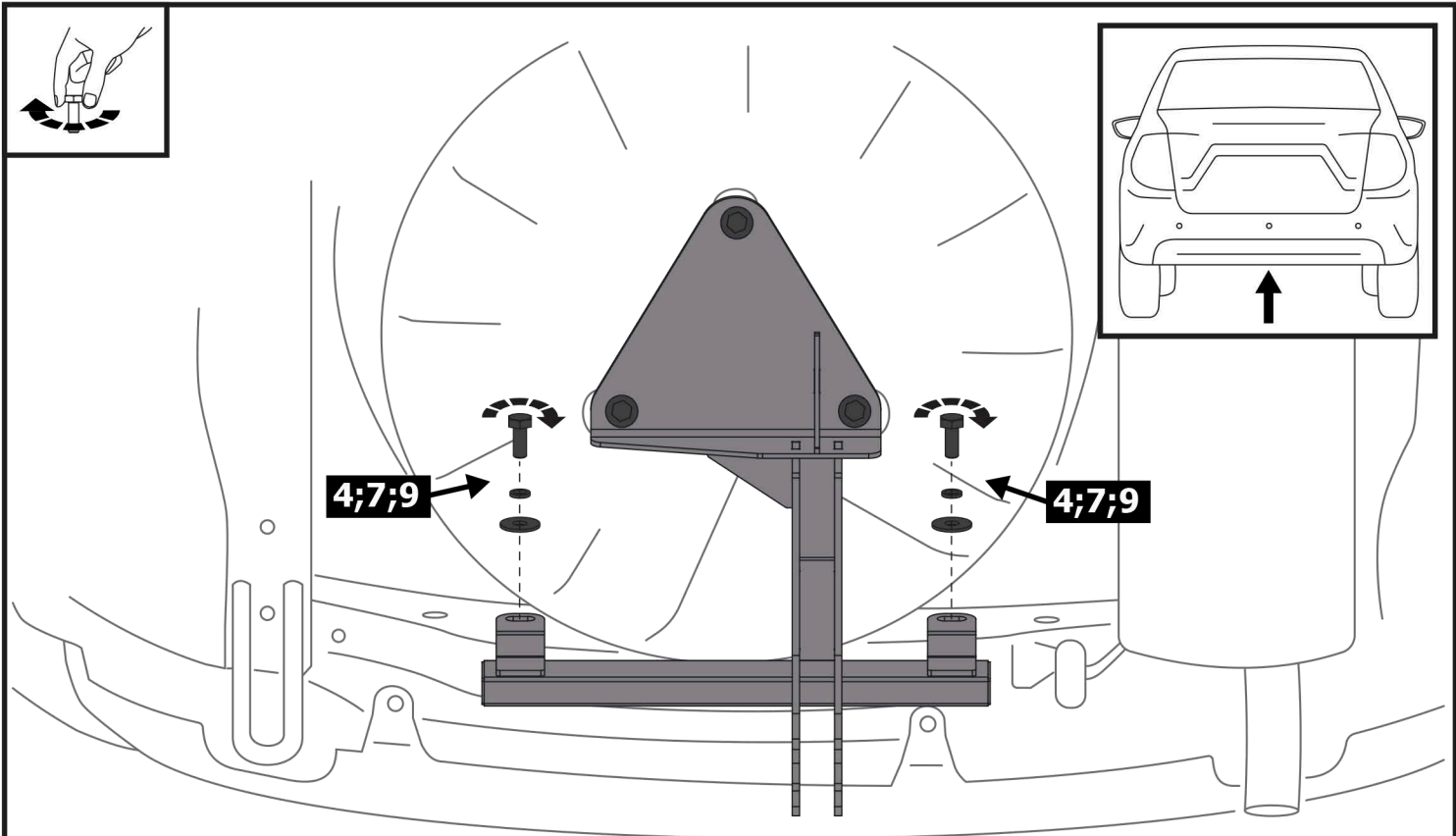

**3**

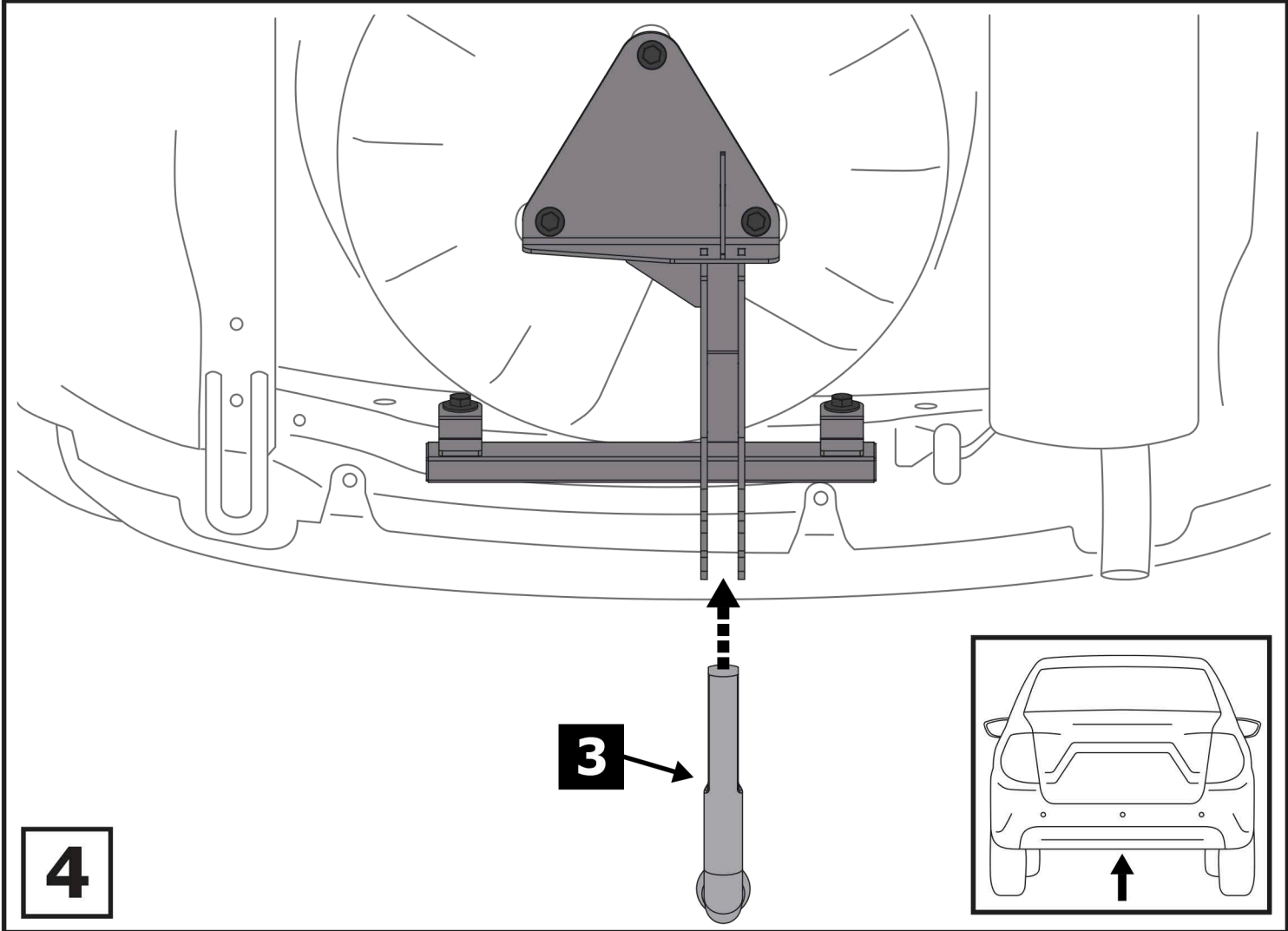

**4**

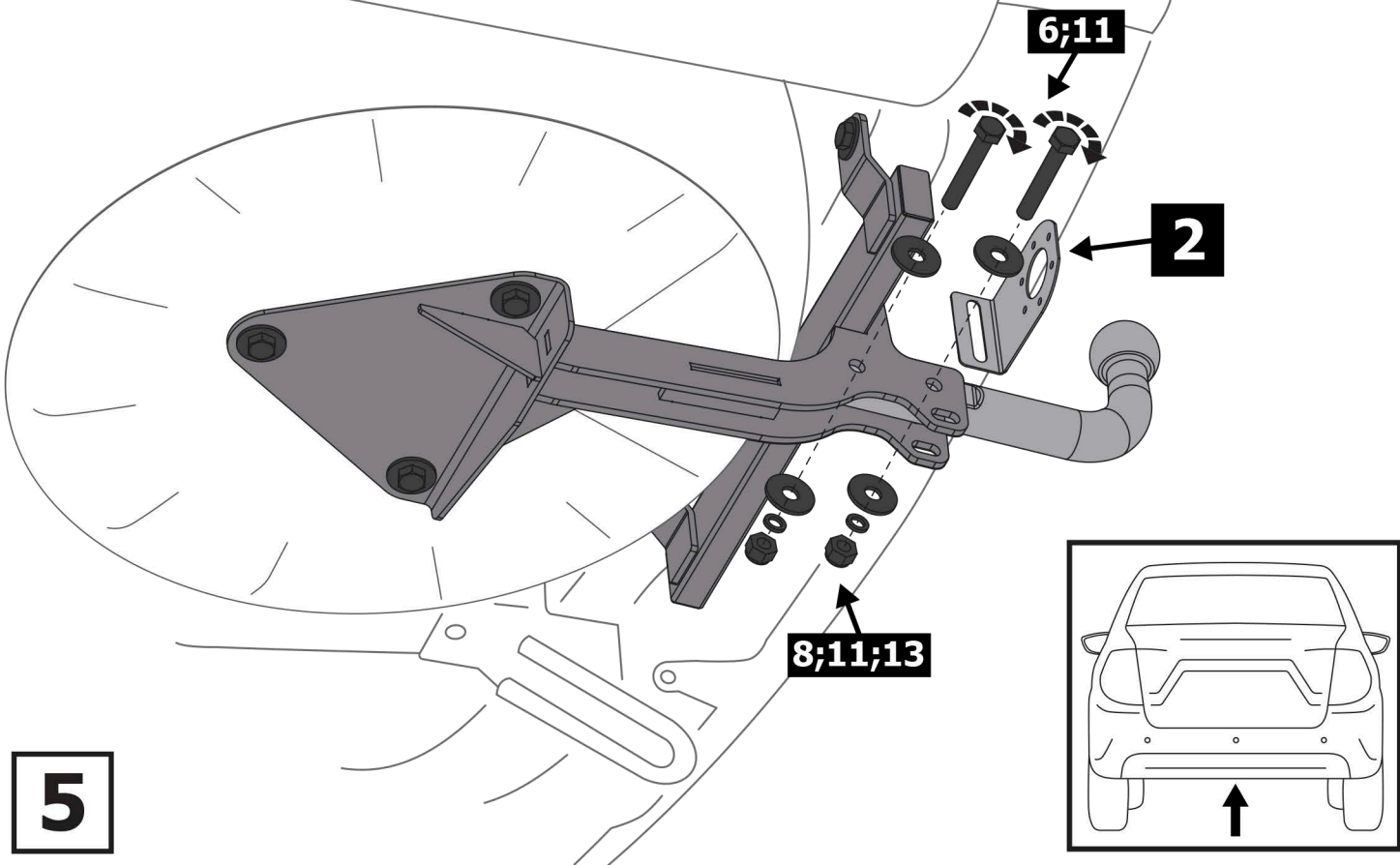

**5**

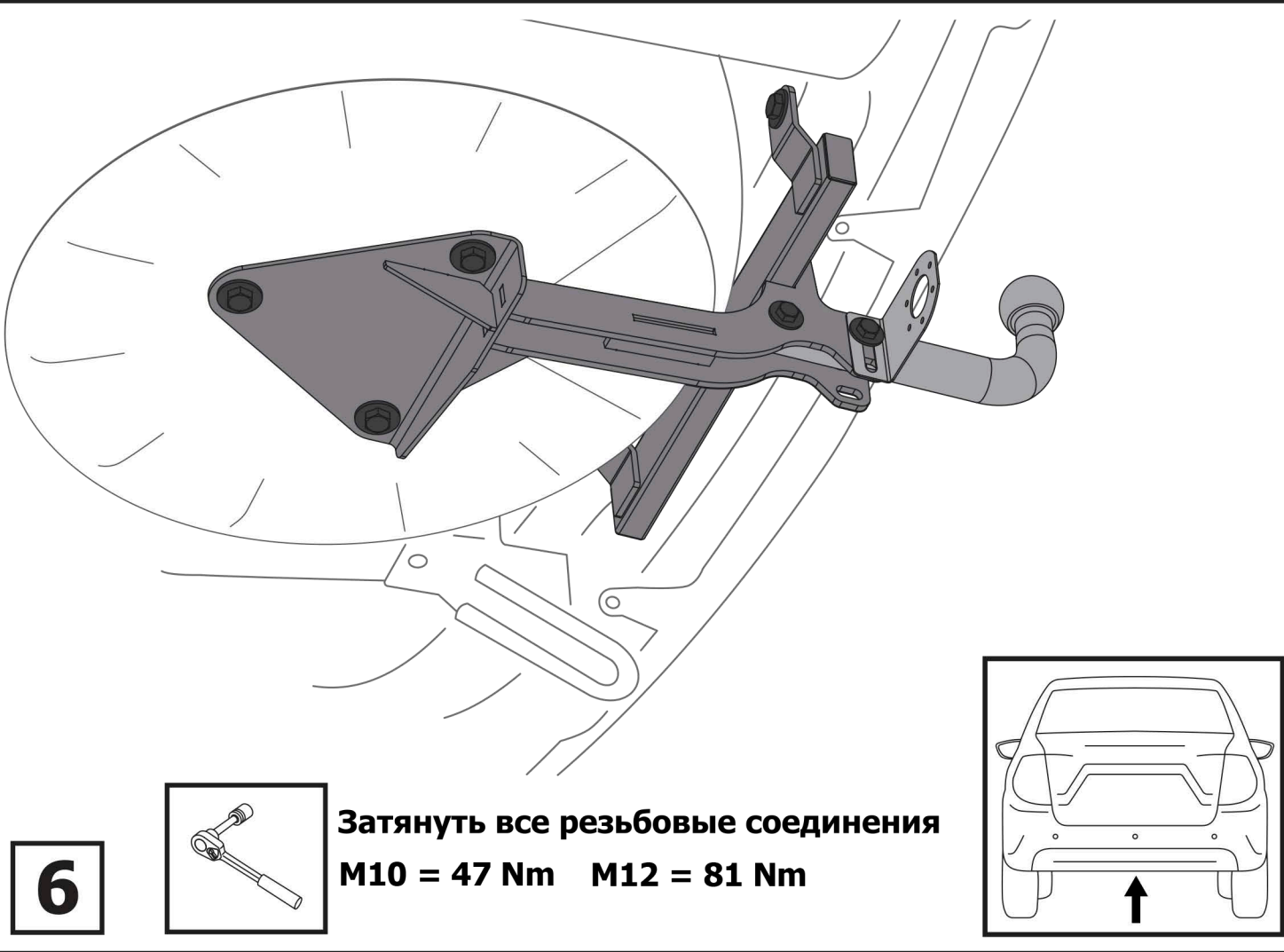

**6**

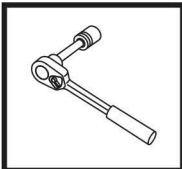

**Затянуть все резьбовые соединения**  
**M10 = 47 Nm M12 = 81 Nm**

