

Инструкция по установке

LADA 4x4 URBAN

(2014-)

LADA LEGEND URBAN

(2021-)



Арт.: F.6017.003

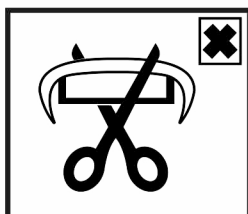
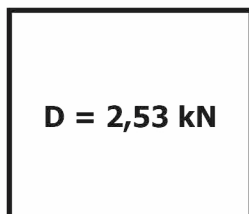
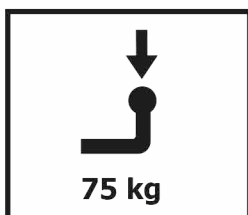
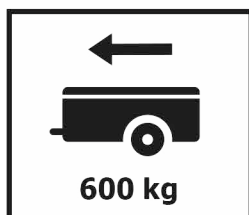

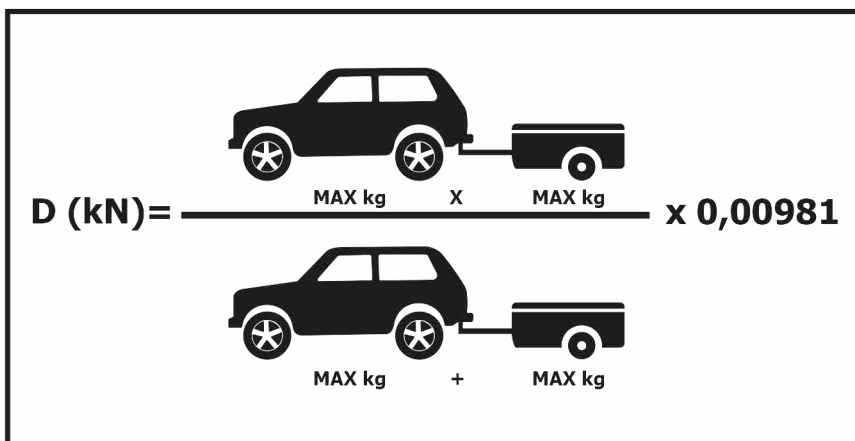
$$D \text{ (kN)} = \frac{\text{MAX kg} \times \text{MAX kg}}{\text{MAX kg} + \text{MAX kg}} \times 0,00981$$

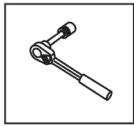

Вкрутить/выкрутить используя инструмент

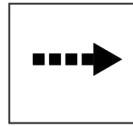

Движение

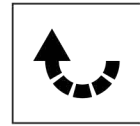

Поворот





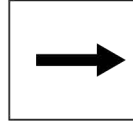



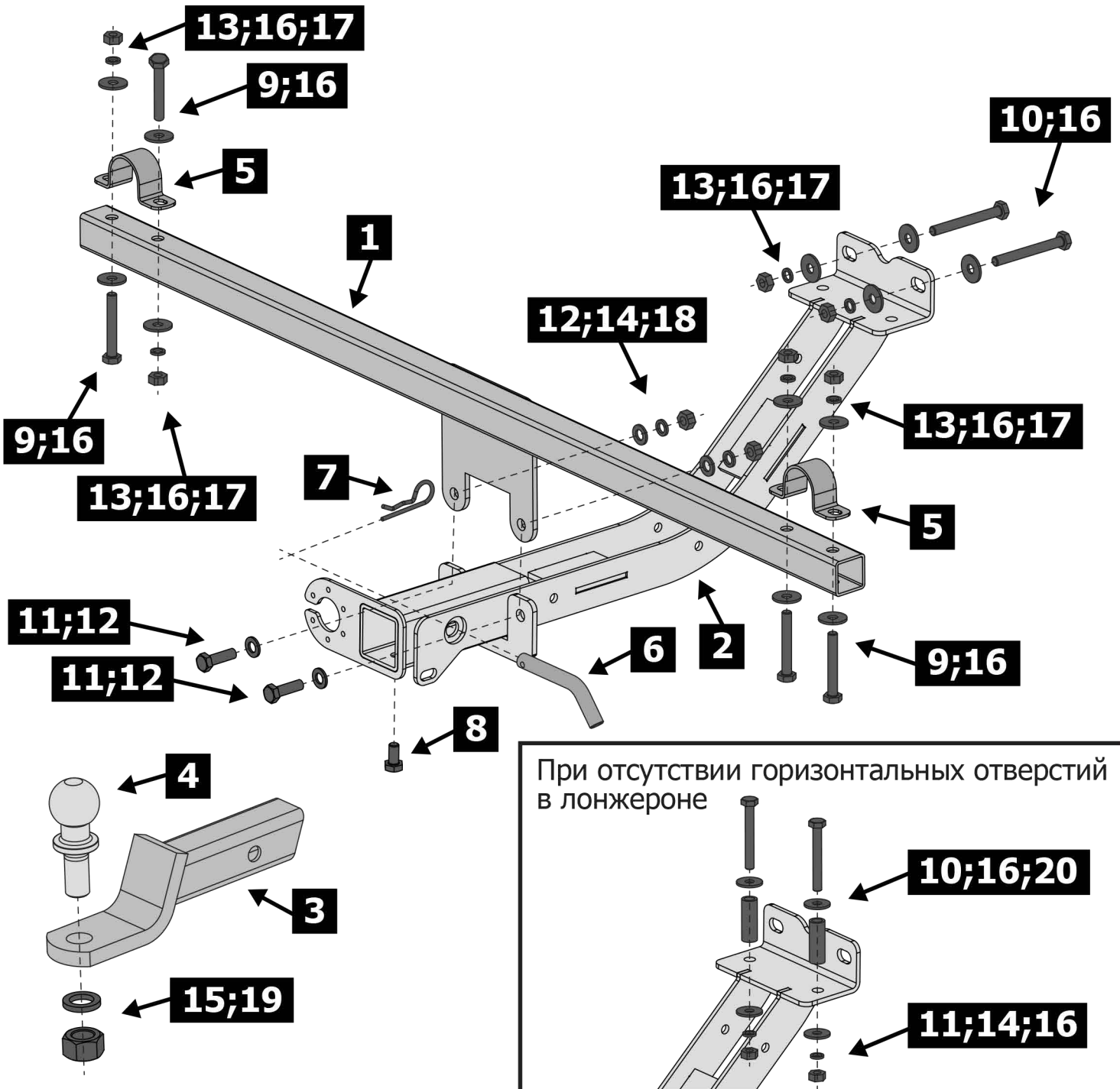
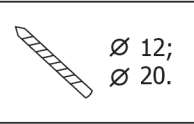
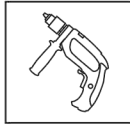
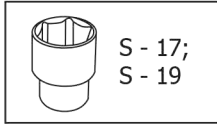
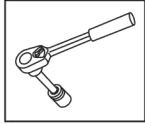

Вкрутить/выкрутить не затягивая

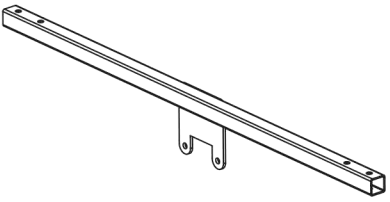
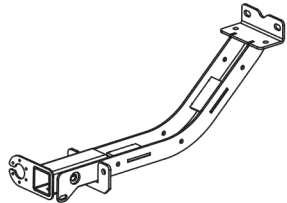
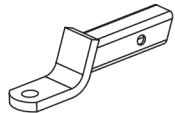

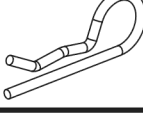
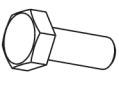
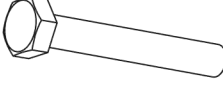
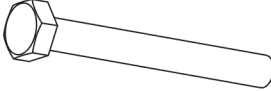
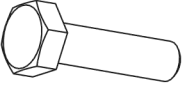

Расположение

Используемый инструмент:

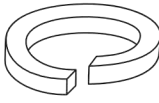

1	x1	Балка	
2	x1	Кронштейн	
3	x1	Переходник	
4	x1	Шар	
5	x2	Скоба	
6	x1	Штифт	
7	x1	Шплинт	
8	x1	M10x20	
9	x4	M10x70	
10	x2	M10x90	
11	x2	M12x40	
12	x4	Ø 12	
13	x6	Ø 10	
14	x2	Ø 12	
15	x1	Ø 24	

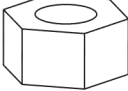
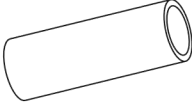
16	x12	Ø 10	
17	x6	M10	
18	x2	M12	
19	x1	M24	
20	x2	Втулка	

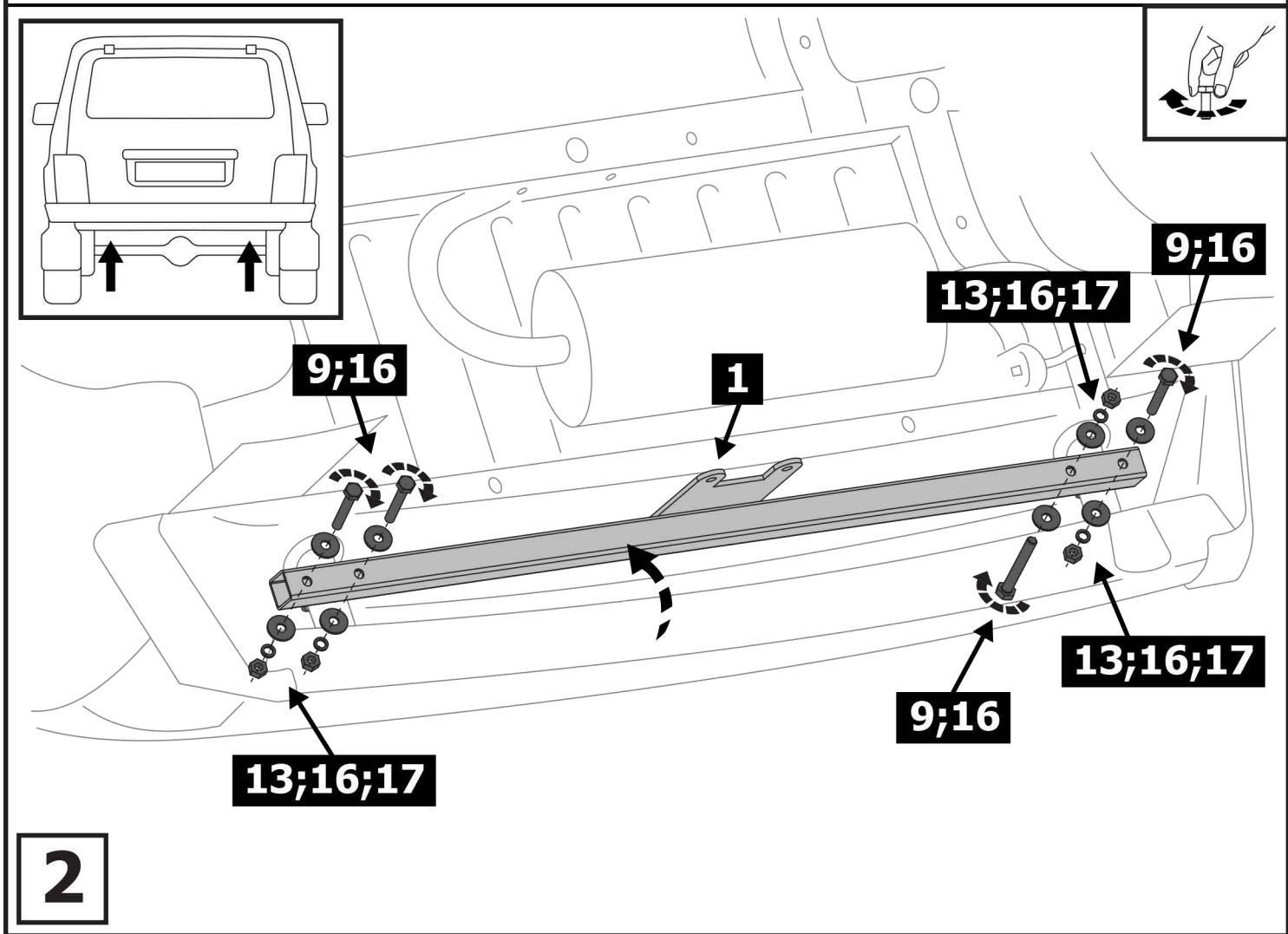
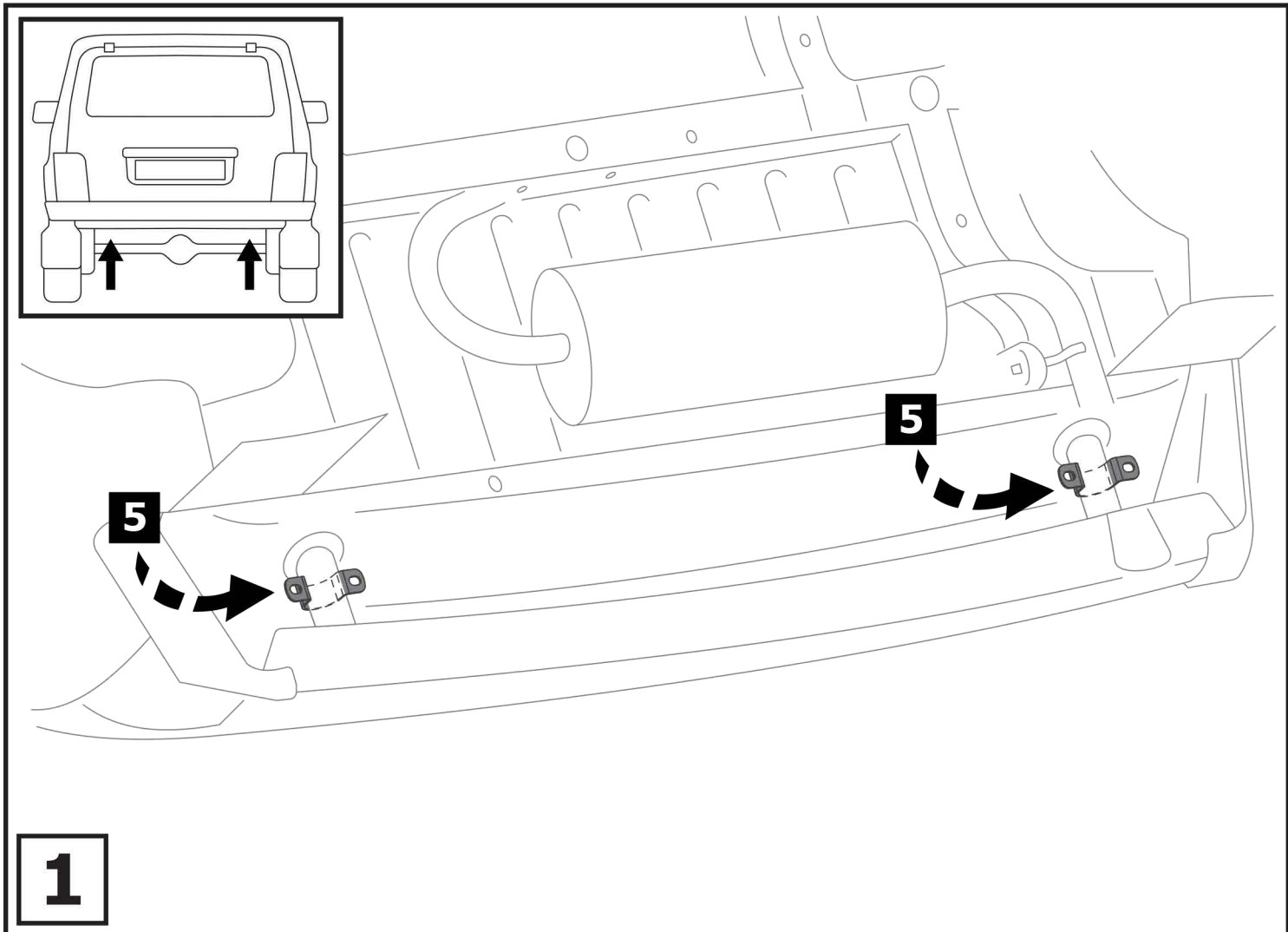

При отсутствии горизонтальных отверстий в лонжероне

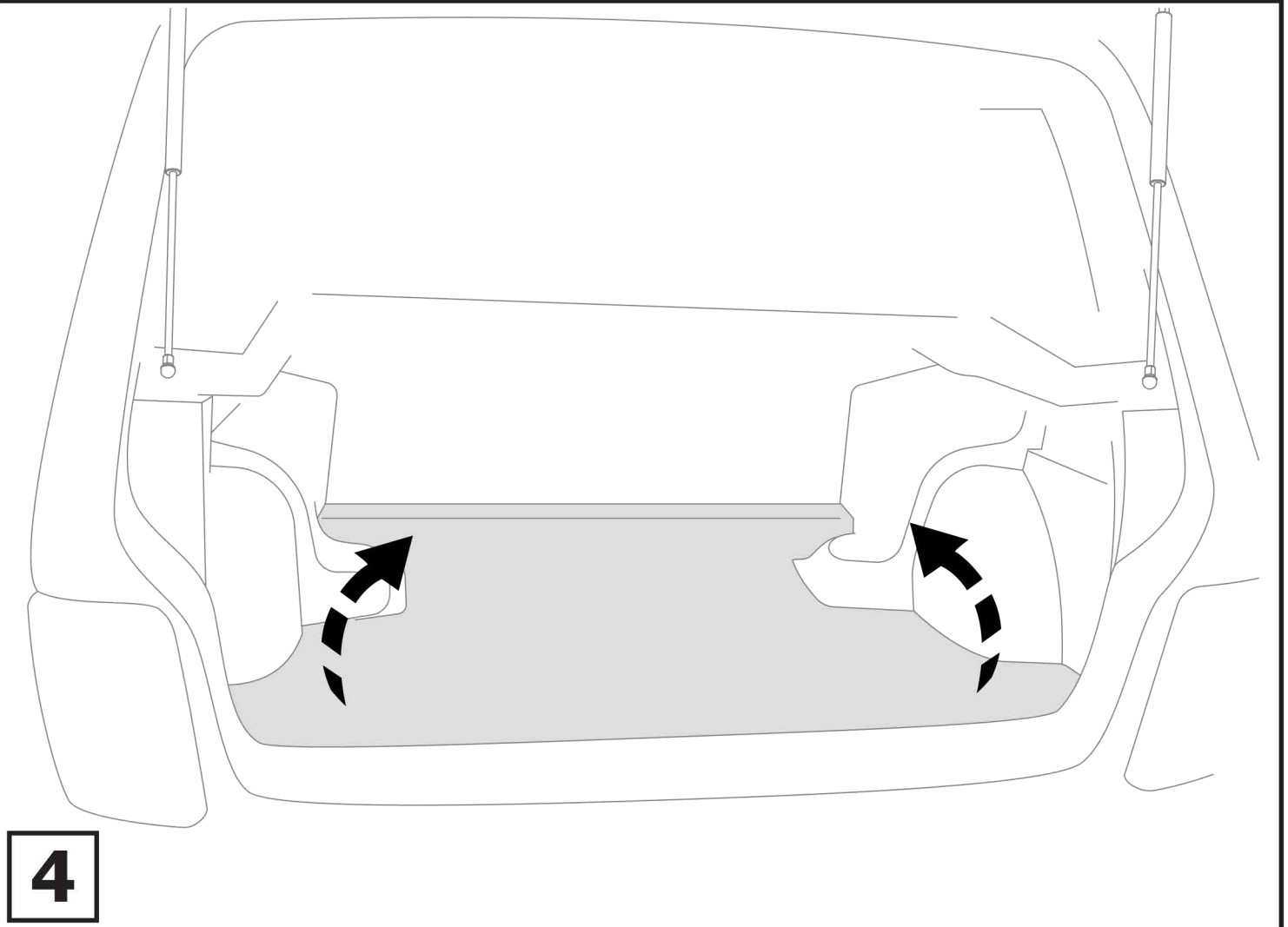
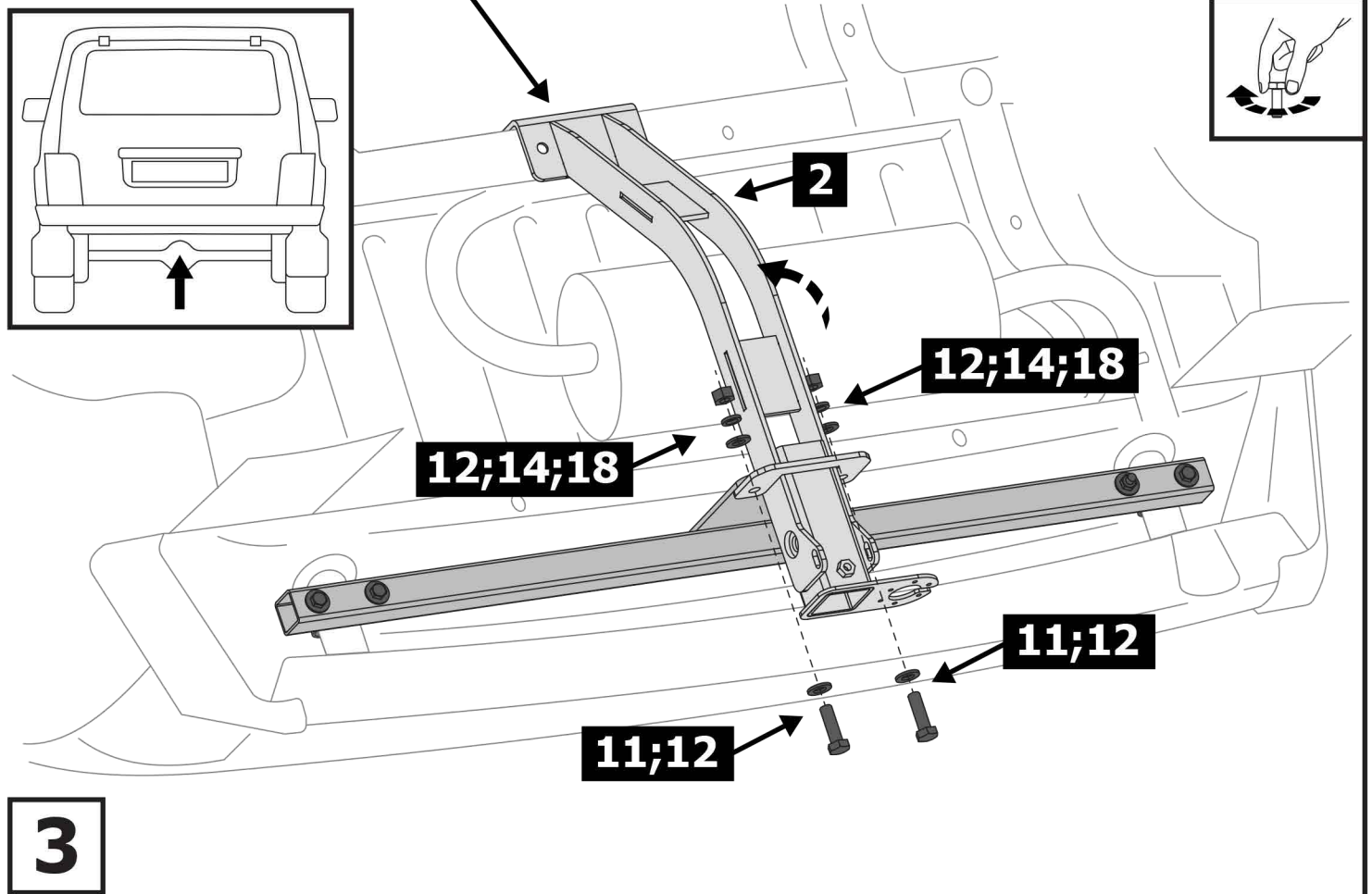

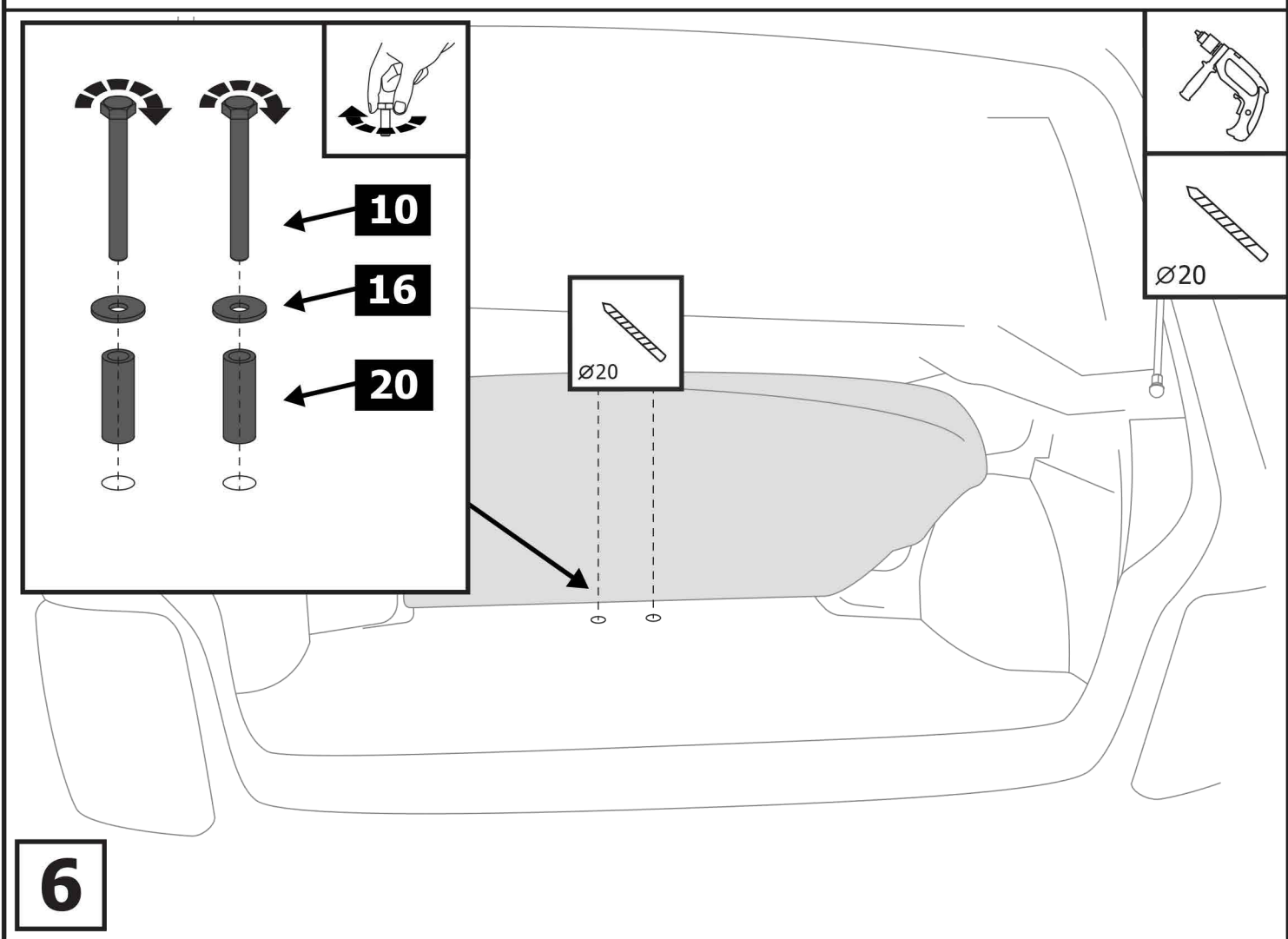
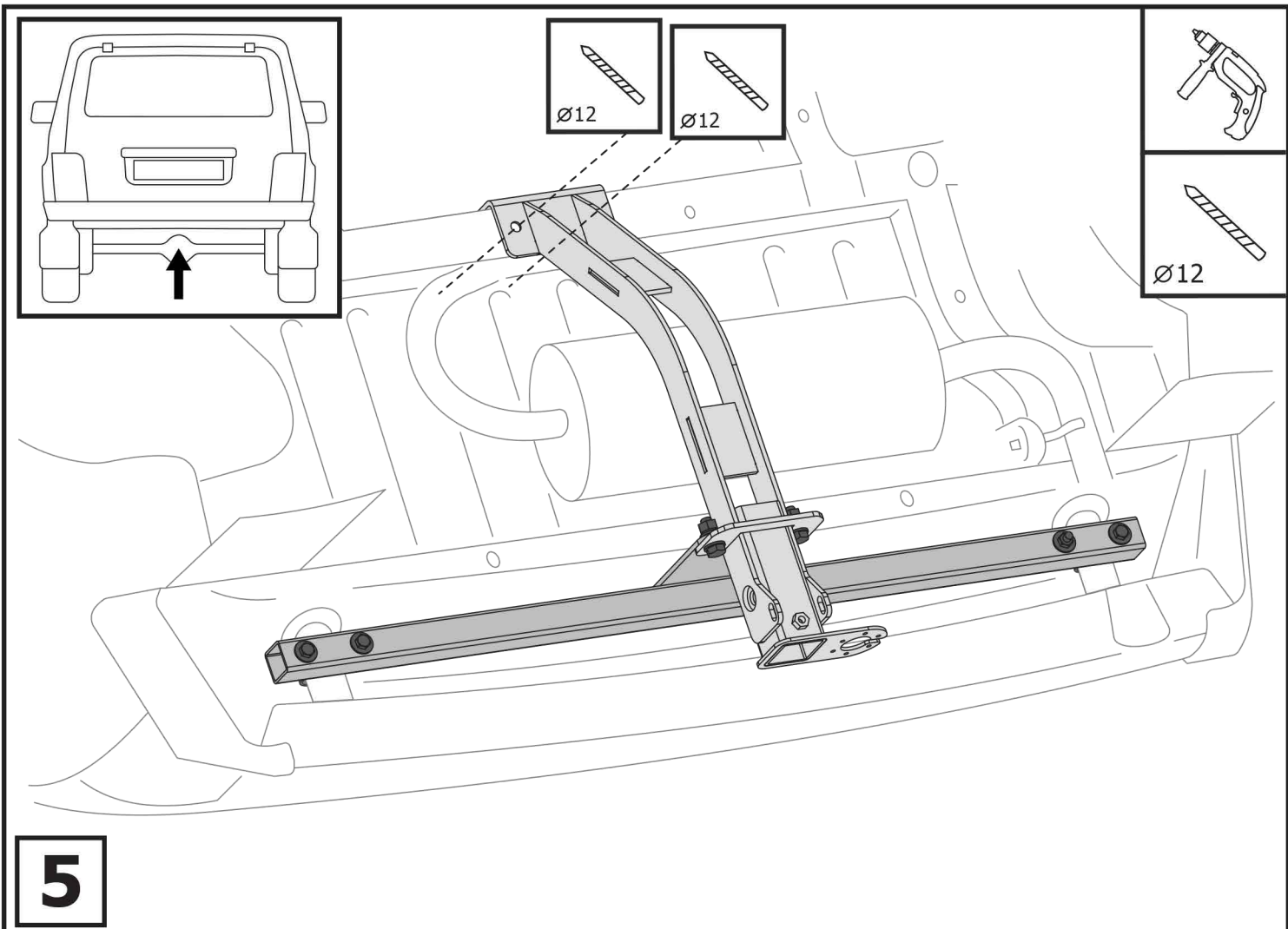

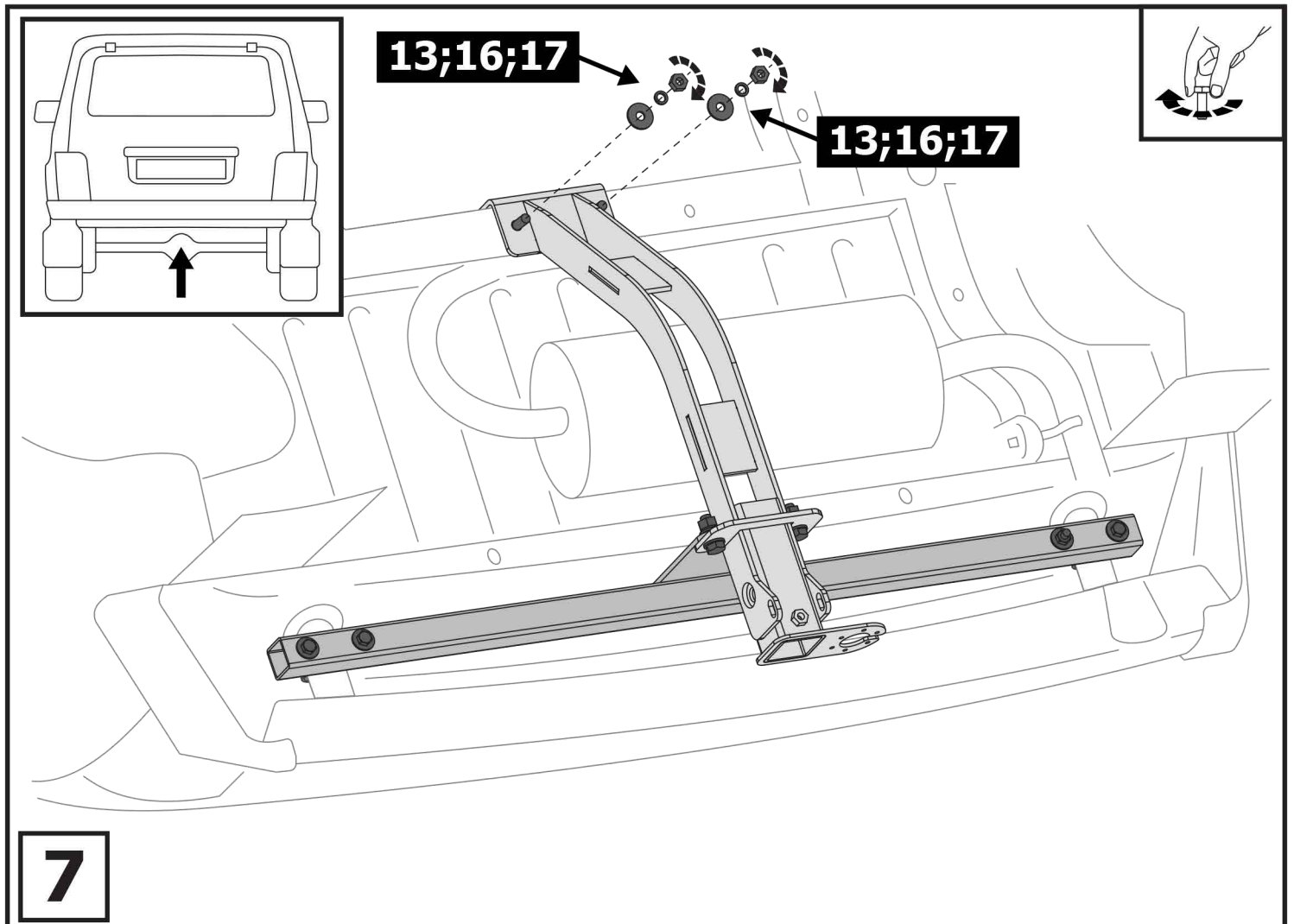

При наличии горизонтальных отверстий в лонжероне

