

# Инструкция по установке

**UAZ Hunter (2003-)**













**UAZ 469 (1972-1985; 2010-2011)**

**UAZ 3151/31512 (1985-2013)**

Арт.: F.6312.001



Тип шара - «А»

 <p>MAX kg    X    MAX kg</p>	 <p>1000 kg</p>	 <p>75 kg</p>	<p>D = 7,1 kN</p>						
$D \text{ (kN)} = \frac{\text{MAX kg} \times \text{MAX kg}}{\text{MAX kg} + \text{MAX kg}} \times 0,00981$  <p>MAX kg    +    MAX kg</p>	<table border="1"> <tr> <td data-bbox="976 1892 1324 2004">UAZ Hunter (2003-)</td> <td data-bbox="1324 1892 1497 2004">  <input checked="" type="checkbox"/> </td> </tr> <tr> <td data-bbox="976 2004 1324 2116">UAZ 469 (1972-1985; 2010-2011)</td> <td data-bbox="1324 2004 1497 2116">  <input checked="" type="checkbox"/> </td> </tr> <tr> <td data-bbox="976 2116 1324 2181">UAZ 3151/31512 (1985-2013)</td> <td data-bbox="1324 2116 1497 2181">  <input checked="" type="checkbox"/> </td> </tr> </table>			UAZ Hunter (2003-)	 <input checked="" type="checkbox"/>	UAZ 469 (1972-1985; 2010-2011)	 <input checked="" type="checkbox"/>	UAZ 3151/31512 (1985-2013)	 <input checked="" type="checkbox"/>
UAZ Hunter (2003-)	 <input checked="" type="checkbox"/>								
UAZ 469 (1972-1985; 2010-2011)	 <input checked="" type="checkbox"/>								
UAZ 3151/31512 (1985-2013)	 <input checked="" type="checkbox"/>								

# Используемый инструмент:

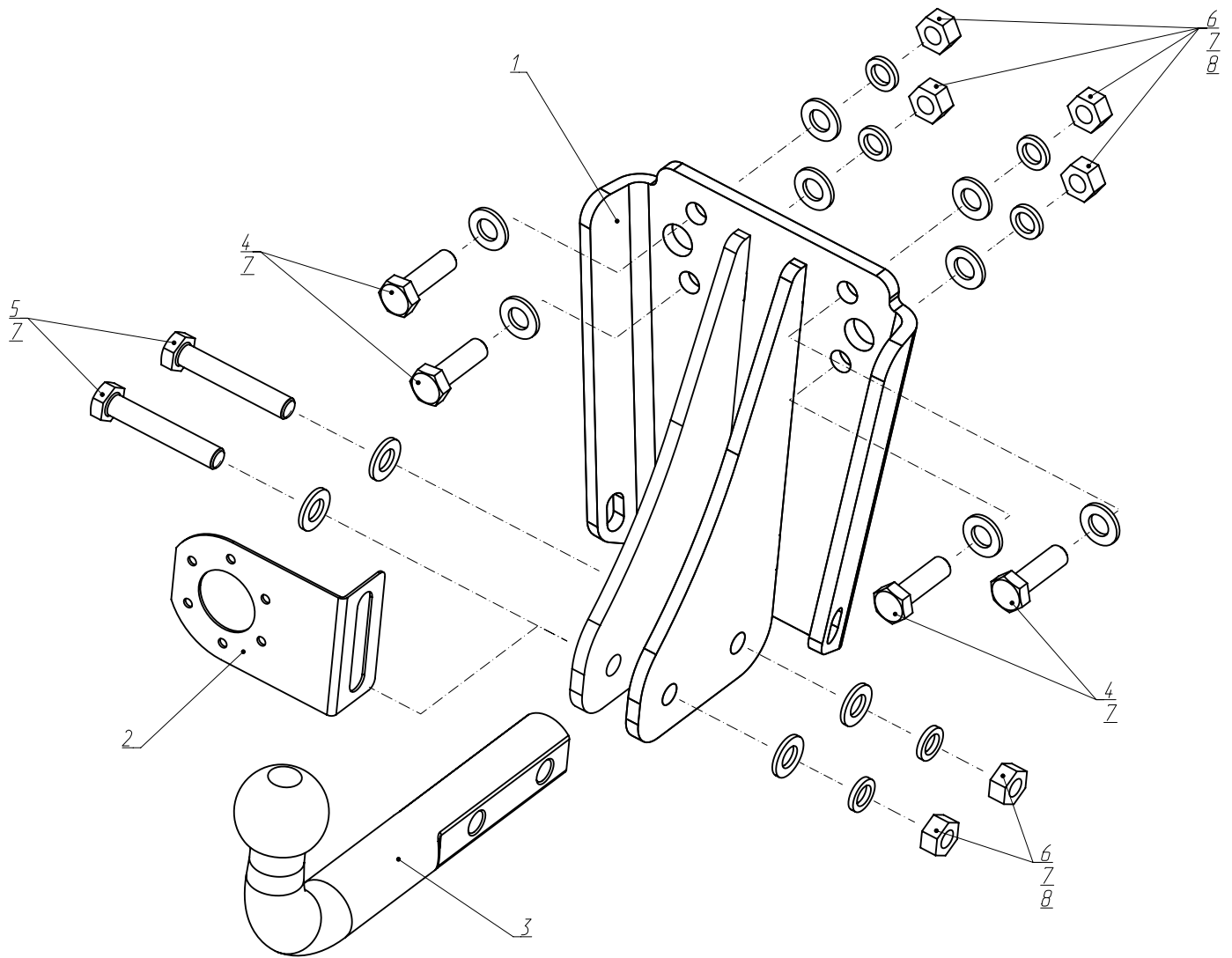
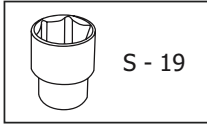
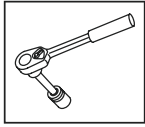







**1**

Закрепить кронштейн ТСУ (1) к отверстиям А в задней части рамы автомобиля при помощи болтов М12х1,25х40 (4), шайб 12 (7), шайб 12 пружинных (8) и гаек М12х1,25 (6).





**3****4**

Затем закрепить кронштейн под розетку (2) и крюк (3) к кронштейну ТСУ (1) при помощи болтов М12х1,25х70 (5), шайб 12 (7), шайб 12 пружинных (8) и гаек М12х1,25 (6).



**5**



**Затянуть все резьбовые соединения. Моменты затяжки: M12=81 Нм.**