

 **OPEL Vectra B**
4dc, 5dv, kombi

 **1995 - 2003**

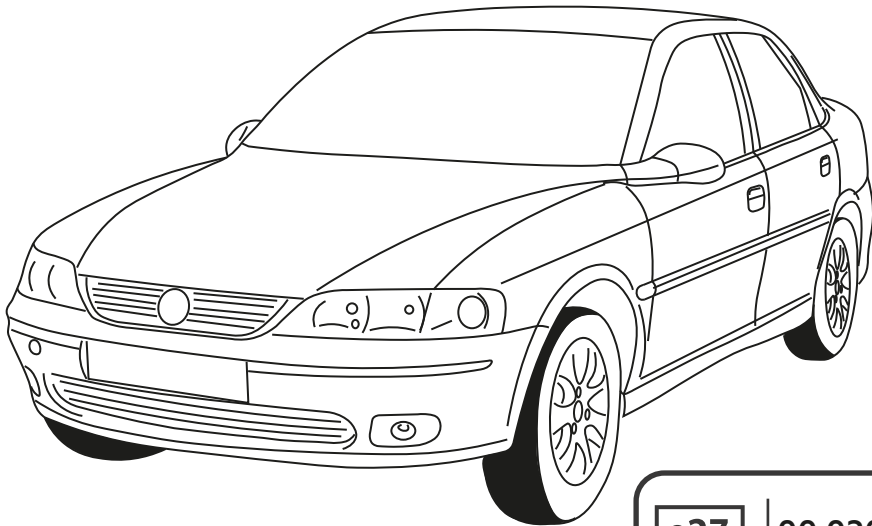



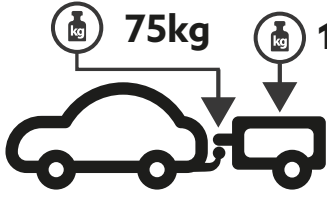

e27 | **00 0303**

$$D = \frac{\text{MAX kg} \times \text{MAX kg}}{\text{MAX kg} + \text{MAX kg}} \times 0,00981$$

 **75kg** **1 500kg**

$$D = 8,67 \text{ kN}$$

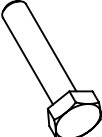
-  R18-66 - 3x
R18-76 - 1x
-  PM10x30 - 1x
-  PP10 - 9x
PP12 - 2x (A,I)
PP12 - 4x (C)
-  M10 - 5x
M12 - 2x (A,I)
-  M10x30 - 4x
M10x100 - 2x
M10x110 - 2x
M12x70 - 2x (A)
M12x90 - 2x (I)
M12x19 - 3x (C)
M12x21 - 1x (C)
- 

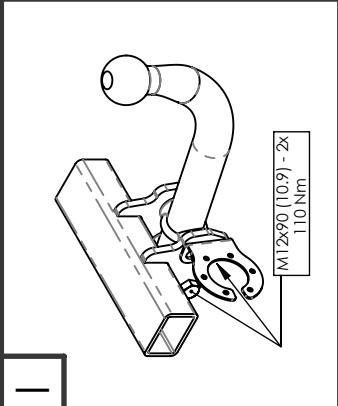
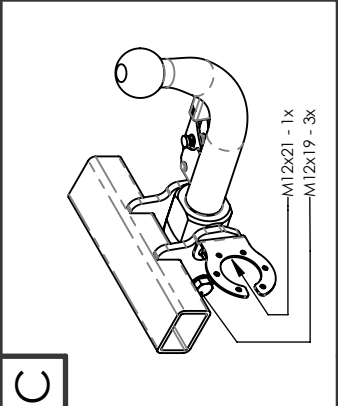
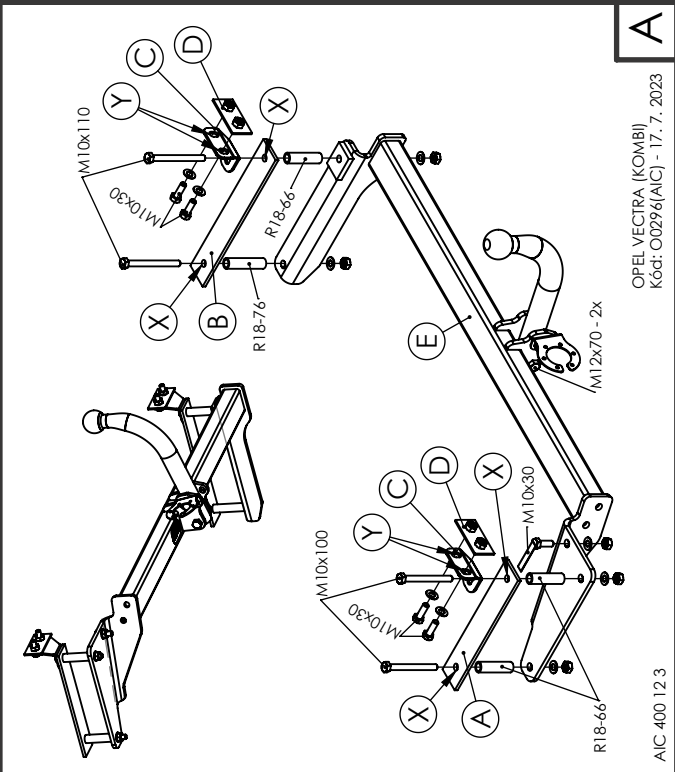

A
OPEL VECTRA (KOMBI)
Kód: 00296(A,C) - 17. 7. 2023
AIC-400.12.3

