

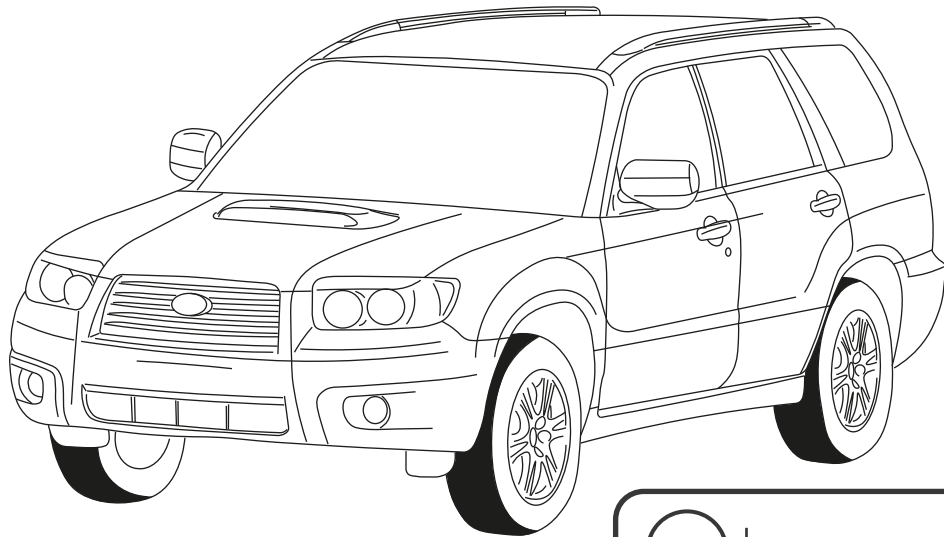

SUBARU
Forester



2008 - 2013



E27

55R-01 0048 00

$$D = \frac{\text{MAX kg} \times \text{MAX kg}}{\text{MAX kg} + \text{MAX kg}} \times 0,00981$$

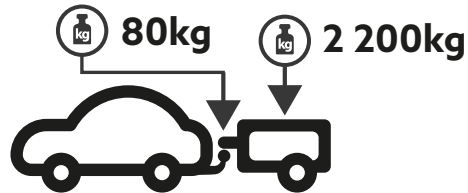

$$D = 10,54\text{kN}$$

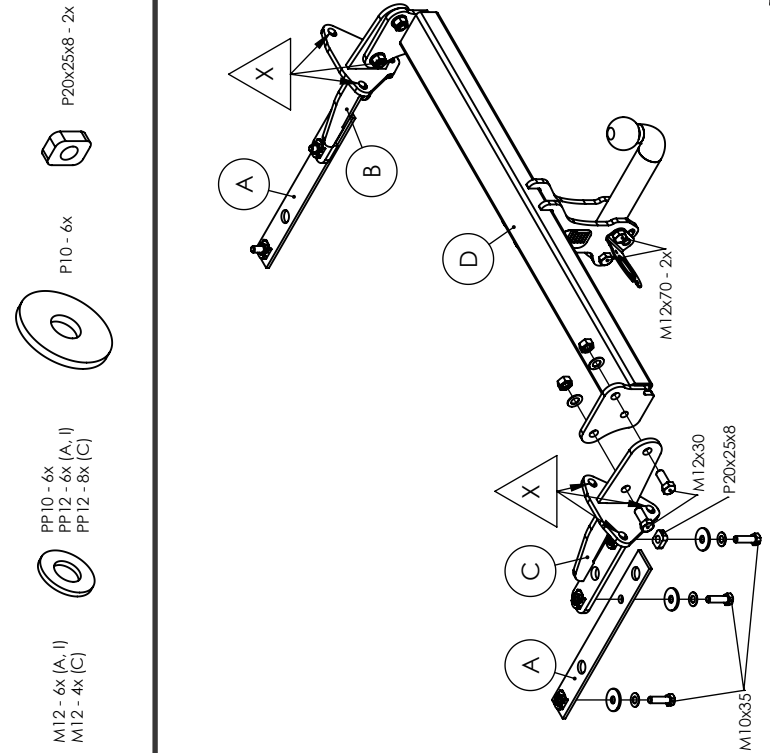

- M10x35 - 6x
- M12x30 - 4x
- M12x70 - 2x (A)
- M12x90 - 2x (I)
- M12x19 - 3x (C)
- M12x21 - 1x (C)

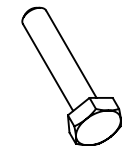

- M12 - 6x (A, I)
- M12 - 4x (C)



- PP10 - 6x
- PP12 - 6x (A, I)
- PP12 - 8x (C)

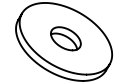

P10 - 6x



P20x25x8 - 2x

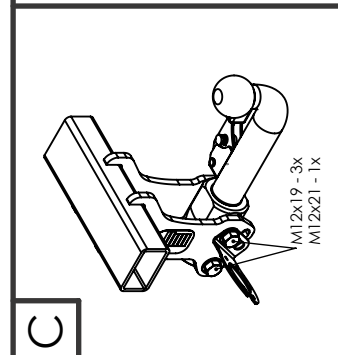

C

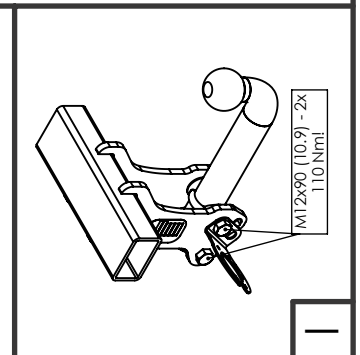

I

A

SUBARU FORESTER
Kód: S1035(A,I,C) 29. 10. 2022

AIC 325 0 1



Location
Vlachy 142, 032 13 Vlachy



Phone
+ 421 44 55 93 434



Website
www.galia.sk



Email
galia@galia.sk



Location
Vlachy 142, 032 13 Vlachy



Phone
+ 421 44 55 93 434



Website
www.galia.sk



Email
galia@galia.sk

